

# RECAMBIOS



# ADAPTABLES

8º EDICIÓN (2024)

MULTIPLICADOR M6 1:3,8



FIGURA	DESCRIPCIÓN	CÓDIGO
1	MULTIPLICADOR M6 1:3,8	TP341
2	RODAMIENTO CÓNICO EJE MULTIPLICADOR	TP351
3	CHAVETA (8x7x35)	TP168
4	RETÉN EJE PIÑÓN MULTIPLICADOR	TP352
5	PIÑÓN MULTIPLICADOR 1:3,8	TP353
6	RODAMIENTO CÓNICO EJE SALIDA MULTIPLICADOR	TP354
7	RETÉN EJE SALIDA MULTIPLICADOR	TP355
8	BRIDA BOMBA	TP356
9	TAPA SUPERIOR MULTIPLICADOR	TP357
10	RODAMIENTO CÓNICO MULTIPLICADOR	TP358
11	EJE PIÑÓN CAJA MULTIPLICADORA	TP359
12	EJE SALIDA MULTIPLICADOR	TP360
13	RETÉN EJE SALIDA MULTIPLICADOR	TP361
14	PIÑÓN MULTIPLICADOR	TP362
15	EJE PIÑÓN SALIDA MULTIPLICADOR 1:3,8	TP363
16	TAPA INFERIOR MULTIPLICADORA	TP424
17	JUNTA CAJA MULTIPLICADORA	TP425
18	TAPÓN CON IMÁN BZ	TP769
19	ARANDELA M10 MULTIPLICADORA BZ	TP819
19	ARANDELA M12 MULTIPLICADORA BZ	TP820

MULTIPLICADOR M6 1:4,8





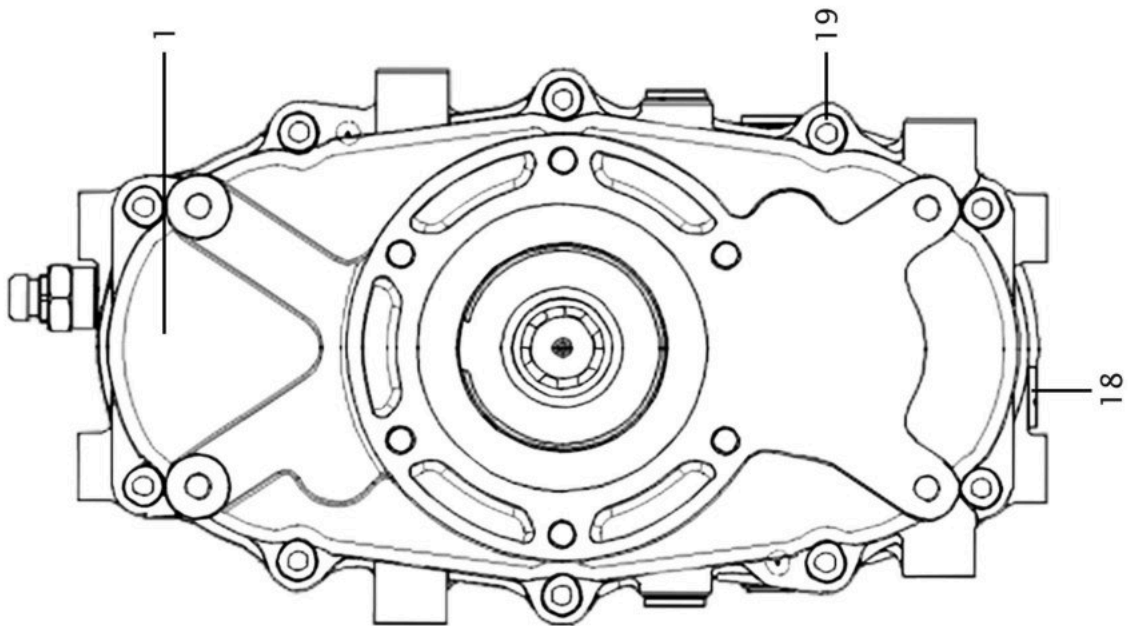
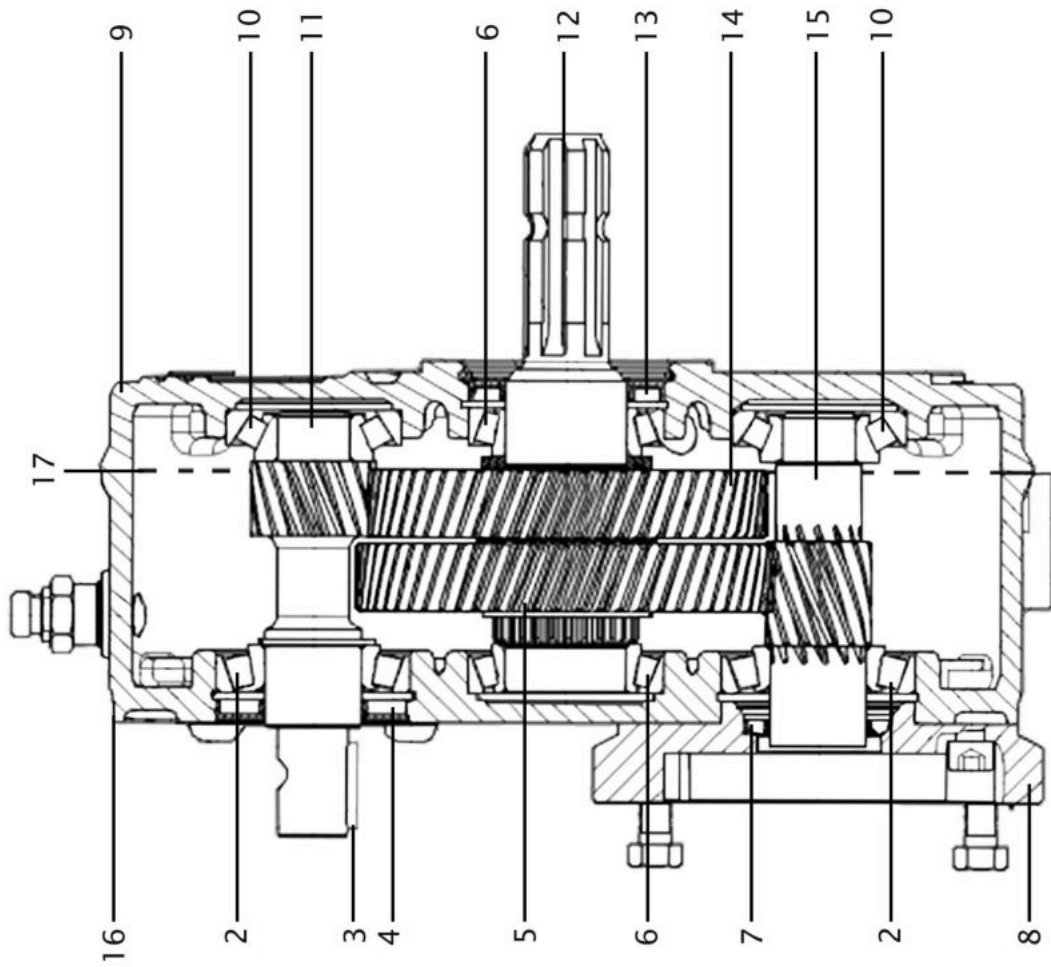

FIGURA	DESCRIPCIÓN	CÓDIGO
1	MULTIPLICADOR M6 1:4,8	TP364
2	RODAMIENTO CÓNICO EJE MULTIPLICADOR	TP351
3	CHAVETA (8x7x35)	TP168
4	RETÉN EJE PIÑÓN MULTIPLICADOR	TP352
5	PIÑÓN MULTIPLICADOR 1:4,8	TP365
6	RODAMIENTO CÓNICO EJE SALIDA MULTIPLICADOR	TP354
7	RETÉN EJE SALIDA MULTIPLICADOR	TP355
8	BRIDA BOMBA	TP426
9	TAPA SUPERIOR MULTIPLICADOR	TP357
10	RODAMIENTO CÓNICO MULTIPLICADOR	TP358
11	EJE PIÑÓN CAJA MULTIPLICADORA	TP359
12	EJE SALIDA MULTIPLICADOR	TP360
13	RETÉN EJE SALIDA MULTIPLICADOR	TP361
14	PIÑÓN MULTIPLICADOR	TP362
15	EJE PIÑÓN SALIDA MULTIPLICADOR 1:4,8	TP366
16	TAPA INFERIOR MULTIPLICADORA	TP424
17	JUNTA CAJA MULTIPLICADORA	TP425
18	TAPÓN CON IMÁN BZ	TP769
19	ARANDELA M10 MULTIPLICADORA BZ	TP819
19	ARANDELA M12 MULTIPLICADORA BZ	TP820

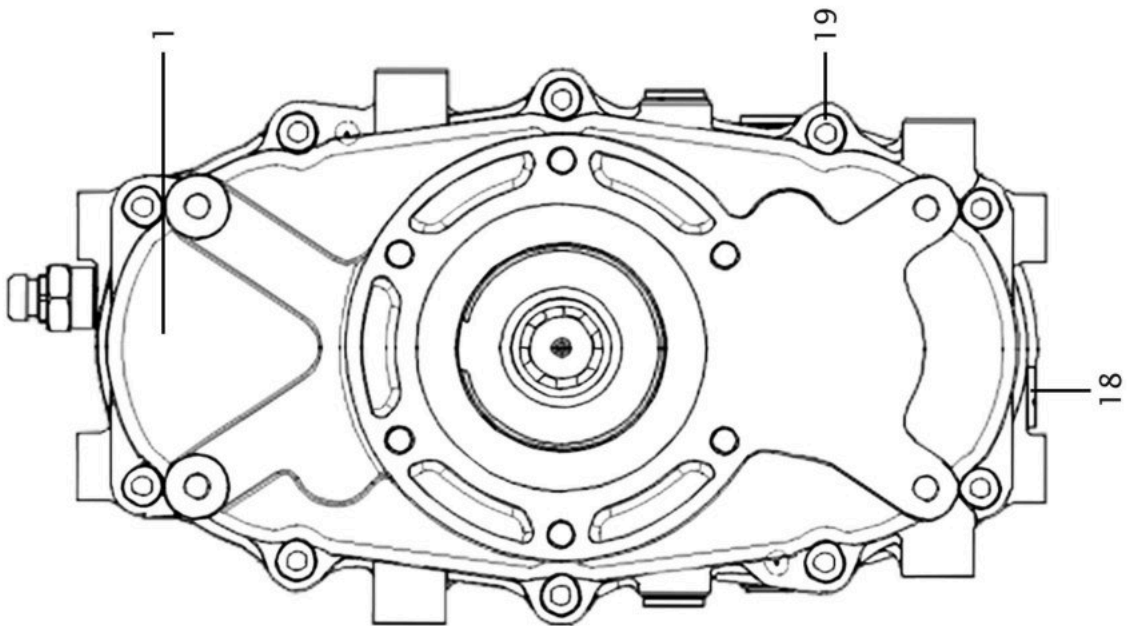
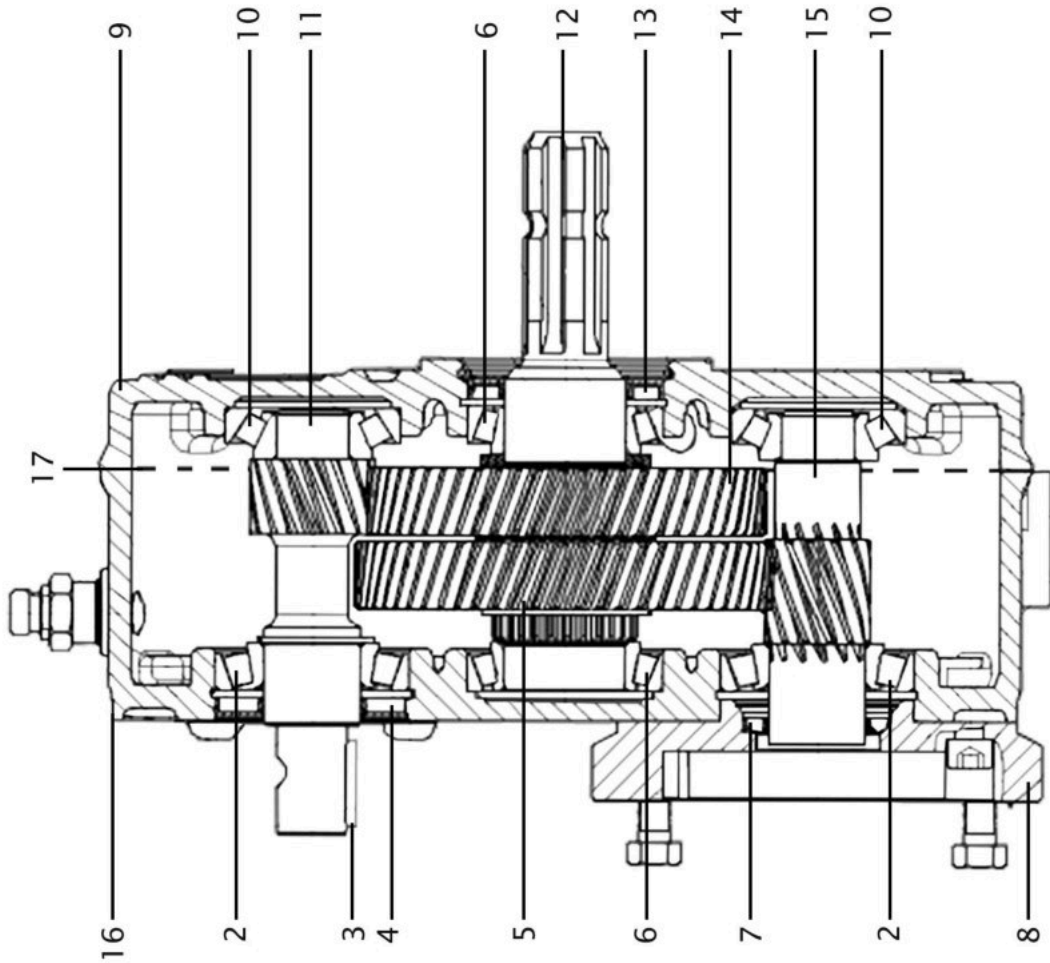

	INVERSOR DE GIRO TOMA DE FUERZA DELANTERA	TP207
	INVERSOR DE GIRO Y REDUCTOR	TP439
	MULTIPLICADORA M5	TP763
	MULTIPLICADOR 1:3,5	TP027
	MULTIPLICADOR 1:2	TP321
	MULTIPLICADOR 1:2,5	TP322
	JUNTA MULTIPLICADOR	TP320
	RETÉN CIEGO MULTIPLICADORA	TP499
	EJE SALIDA MULTIPLICADOR	TP273
	RODAMIENTO PIÑÓN PEQUEÑO MULTIPLICADORA	TP342
	RODAMIENTO PIÑÓN MULTIPLICADORA	TP344
	RODAMIENTO PIÑÓN GRANDE MULTIPLICADORA	TP343
	RETÉN SALIDA MULTIPLICADOR	TP276
	RETÉN ENTRADA MULTIPLICADOR	TP277
	PIÑÓN PEQUEÑO MULTIPLICADOR	TP274
	CORONA GRANDE MULTIPLICADOR	TP275

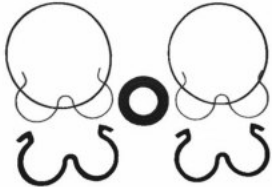

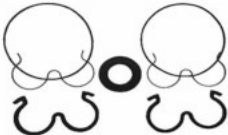

## BOMBAS GRUPO 3 EJE CÓNICO

	<p>BOMBA HIDRÁULICA PRINCIPAL 3SP A33 D-10G 3SP A34 D-10G</p>	TP029
	<p>BOMBA HIDRÁULICA PRINCIPAL 3SP A36 D-10G 3SP A37 D-10G</p>	TP221
	<p>BOMBA HIDRÁULICA PRINCIPAL ROSCADA 3SP A44 D-10G</p>	TP054
	<p>BOMBA HIDRÁULICA PRINCIPAL CON BRIDA 3SP A44 D-10G</p>	TP447
	<p>BOMBA HIDRÁULICA PRINCIPAL ROSCADA 3SP A52 D-10G 3SP A53 D-10G</p>	TP149
	<p>BOMBA HIDRÁULICA PRINCIPAL CON BRIDA 3SP A53 D-10G</p>	TP448
	<p>MANGUITO ESTRIADO</p>	TP028
	<p>CHAVETA MEDIA LUNA (4x7.5x19)</p>	TP148
	<p>JGO DE RETENES BOMBA PRINCIPAL</p>	TP147
	<p>JGO DE RETENES BOMBA PRINCIPAL (TAPA FUNDIDO)</p>	TP431
	<p>RETÉN BOMBA PRINCIPAL</p>	TP252
	<p>RETÉN BOMBA PRINCIPAL (TAPA FUNDIDO)</p>	TP432

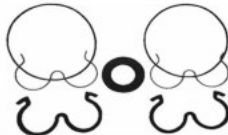

## BOMBAS GRUPO 2 EJE CÓNICO

	BOMBA SECUNDARIA EJE CÓNICO 2SP A8 D-10G	TP251
	BOMBA SECUNDARIA EJE CÓNICO 2SP A11 D-10G	TP315
	BOMBA SECUNDARIA EJE CÓNICO 2SP A19 D-10G	TP030
	BOMBA SECUNDARIA EJE CÓNICO 2SP A50 D-10G	TP558
	JGO DE RETENES BOMBA SECUNDARIA	TP157
	RETÉN BOMBA SECUNDARIA	TP228



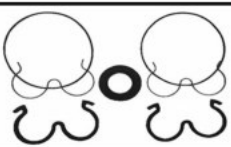

## BOMBAS GRUPO 2 EJE INTERNO



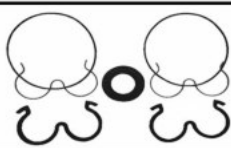

	BOMBA SECUNDARIA EJE INTERNO 2SP A11 D-10G	TP314
	BOMBA SECUNDARIA EJE INTERNO 2SP A16 D-10G	TP430
	BOMBA SECUNDARIA EJE INTERNO 2SP A19 D-10G	TP239
	JGO DE RETENES BOMBA SECUNDARIA	TP157
	RETÉN BOMBA SECUNDARIA	TP228
	EJE INTERNO PARA BOMBA 2SP A19	TP411

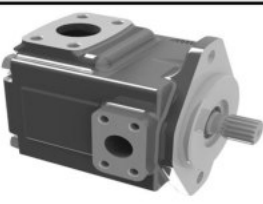
## BOMBAS GRUPO 1 EJE CÓNICO

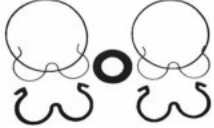

	BOMBA HIDRÁULICA PEQUEÑA EJE CÓNICO 1SP A037 D10G	TP032
	BOMBA HIDRÁULICA PEQUEÑA EJE CÓNICO 1SP A050 D10G	TP558
	BOMBA HIDRÁULICA PEQUEÑA EJE CÓNICO 1SP A063 D10G	TP666
	BOMBA HIDRÁULICA PEQUEÑA EJE CÓNICO M5	TP409
	JGO RETENES BOMBA PEQUEÑA	TP151
	RETÉN BOMBA PEQUEÑA	TP253

## BOMBAS GRUPO 1 EJE INTERNO

	BOMBA HIDRÁULICA PEQUEÑA EJE INTERNO 3.2	TP031
	BOMBA HIDRÁULICA PEQUEÑA EJE INTERNO 5.0	TP414
	JGO RETENES BOMBA PEQUEÑA	TP151
	RETÉN BOMBA PEQUEÑA	TP253
	BOMBA HIDRÁULICA A PARTIR DEL 2015	TP507
	JGO REPARACIÓN BOMBA A PARTIR DEL 2015	TP724

	<p>BOMBA HIDRÁULICA GRUPO 3 DOBLE</p>	<p>TP240</p>
	<p>PRIMER CUERPO 33 cm3 EJE CÓNICO</p>	<p>TP241</p>
	<p>SEGUNDO CUERPO 19 cm3</p>	<p>TP242</p>
	<p>JGO REPARACIÓN PARA BOMBA DOBLE GRUPO 3</p>	<p>TP147</p>
	<p>KIT ADAPTACIÓN BOMBA HIDRÁULICA (GRUPO 3 A GRUPO 2)</p>	<p>TP306</p>
	<p>KIT ADAPTACIÓN BOMBA HIDRÁULICA (GRUPO 2 A GRUPO 1)</p>	<p>TP307</p>
	<p>KIT ADAPTACIÓN BOMBA HIDRÁULICA (GRUPO 3 A GRUPO 1 CORTA-EJE INTERNO)</p>	<p>TP308</p>
	<p>KIT ADAPTACION BOMBA HIDRÁULICA (GRUPO 3 A GRUPO 1 LARGA-EJE CÓNICO)</p>	<p>TP309</p>

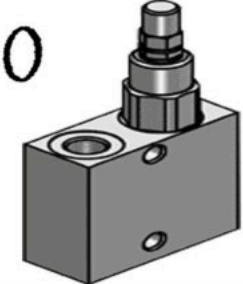
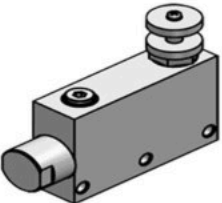
	BLOQUE ABANICO 1 CUERPO	TP919
	BLOQUE ABANICO 2 CUERPOS	TP653
	VÁLVULA REGULADORA PRESIÓN FLUCOM LP130	TP419
	VÁLVULA LIMITADORA FLUCOM LPS20 M6-2003	TP506
	VÁLVULA LIMITADORA PRESIÓN	TP726
	VÁLVULA REDUCTORA PRESIÓN	TP752
	VÁLVULA LIMITADORA PRESIÓN	TP761
	ANTIRETORNO FLUCOM CAS 20/05	TP217
	ANTIRETORNO FLUCOM CAS 20/06	TP218
	ANTIRETORNO FLUCOM CAS 20/07	TP219
	ANTIRETORNO FLUCOM CAS 20/08	TP220
	ANTIRETORNO FLUCOM CAS 20/09	TP316
	ANTIRETORNO FLUCOM CAE 20/M	TP305
	ANTIRETORNO FLUCOM CAE 20/Z	TP305
	TUBO DE 12x300	0943-300
	TUBO DE 12x42	0943-042

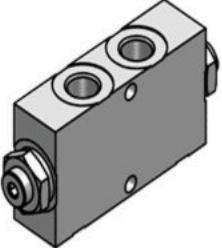
	VÁLVULA DOBLE PILOTADA HEMBRA 3/8	TP302
	VÁLVULA DOBLE PILOTADA HEMBRA 1/2	TP317
	VÁLVULA DOBLE PILOTADA MACHO 18mm	TP303
	PISTÓN PILOTAJE CAE 20 LCS	TP662
	GOMA TÓRICA NEGRA REGULADOR CAJA ACTUADORA	TP310
	GOMA TÓRICA VITÓN REGULADOR CAJA ACTUADORA	TP311
	VÁLVULA SECUENCIAL DE 1/2	TP336
	GOMA TÓRICA PARA VÁLVULA 90SH	TP232
	GOMA TÓRICA PARA VÁLVULA VITÓN	TP164
	REGULADOR DE CAUDAL COMPENSADO DE 3/8	TP337
	REGULADOR DE CAUDAL COMPENSADO DE 1/2	TP338
	REGULADOR DE CAUDAL UNIDIRECCIONAL 3/8	TP339
	REGULADOR DE CAUDAL UNIDIRECCIONAL 1/2	TP340
	REGULADOR DE CAUDAL BIDIRECCIONAL 3/8	TP381
	REGULADOR DE CAUDAL BIDIRECCIONAL 1/2	TP382
	VÁLVULA VIBRACIÓN M5/M6 DEPÓSITO ROJO	TP780
	VÁLVULA ANTIRETORNO DE 1/2	TP410
	JUEGO REPARACIÓN VÁLVULA ANTIRETORNO 1/2	TP412
	ANTIRETORNO ABANICO M6 DEL 2000	TP616











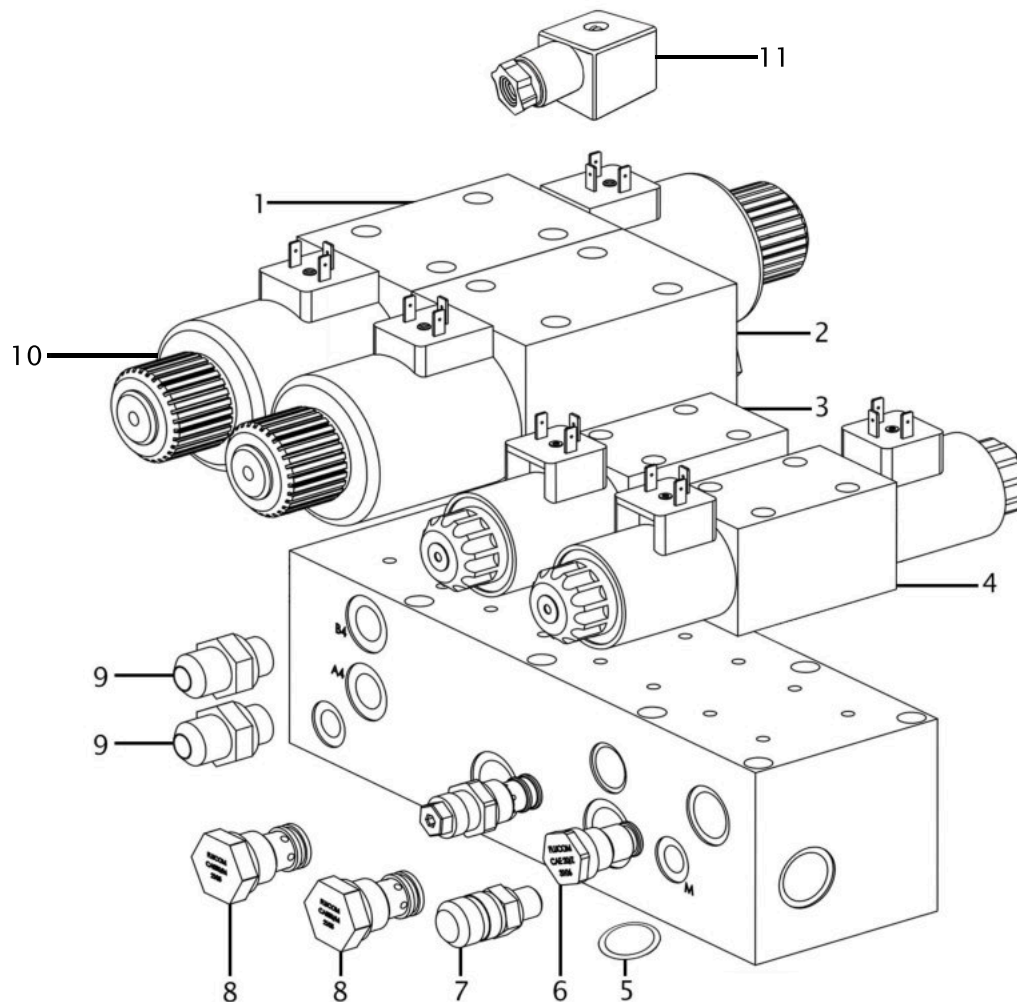



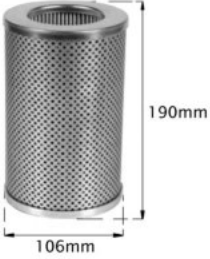
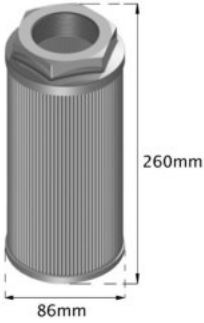

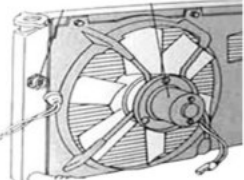
FIGURA	DESCRIPCION	CODIGO
1	ELECTROVÁLVULA ABRIR Y CERRAR LA PINZA	TP458
2	ELECTROVÁLVULA PARA ACTIVAR BOMBA DEL GRUPO 3	TP457
3	ELECTROVÁLVULA PARA ACTIVAR BOMBA DEL GRUPO 2	TP456
4	ELECTROVÁLVULA PARA ABRIR Y CERRAR EL ABANICO	TP455
5	JUNTA TÓRICA PARTE DE ABAJO DEL BLOQUE	TP459
6	ANTIRETORNO FLUCOM CAE 20/Z	TP305
7	MINIMES M16X2 ROSCA 1/4 BSP	TP452
8	ANTIRETORNO FLUCOM CAE 30M	TP453
9	RACOR RECTO JIC 3/4 BSP 3/8	TP454
10	BOBINA NG10 PARA ELECTROVÁLVULA	TP768
11	CONECTOR CORRIENTE ELECTROVÁLVULA	TP803

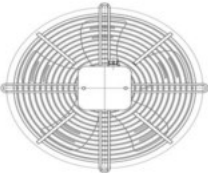
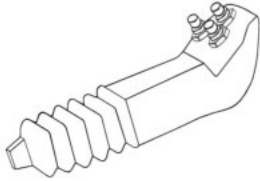
	<p>FILTRO ASPIRACIÓN DE ACEITE M-6 (72x150)</p>	<p>TP129</p>
	<p>FILTRO RETORNO DEPÓSITO (130x140 aprox)</p>	<p>TP166</p>
	<p>FILTRO RETORNO DEPÓSITO (100x205 aprox)</p>	<p>TP178</p>
	<p>FILTRO RETORNO (130x200 aprox)</p>	<p>TP313</p>
	<p>FILTRO DE ASPIRACIÓN M6 HIDRÁULICA 2015</p>	<p>TP165</p>
	<p>FILTRO DE ASPIRACIÓN (86x260 aprox)</p>	<p>TP395</p>
	<p>SOPORTE COMPLETO CON FILTRO TP178</p>	<p>TP208</p>

	ENFRIADOR MODERNO	TP214
	ENFRIADOR ANTIGUO	TP215
	MACHÓN ADAPTADOR ENFRIADOR MODERNO	TP450
	VENTILADOR	TP216
	VENTILADOR ORIGINAL	TP687
	VENTILADOR CUADRADO GRANDE	TP238
	MANDO TOPAVI 3 BOTONES HASTA 2003	TP383
	BOTÓN ROJO PARA MANDO A PARTIR 2004	TP385
	BOTÓN VERDE PARA MANDO A PARTIR 2004	TP403
	BOTÓN AZUL PARA MANDO A PARTIR 2004	TP404
	BOTÓN AMARILLO PARA MANDO A PARTIR 2004	TP405
	RELÉ	TP433
	RELÉ	TP434
	PULSADOR VIBRO M6 ANTIGUA HASTA 2003	TP435
	INTERRUPTOR ABANICO M6 ANTIGUA HASTA 2003	TP436
	INTERRUPTOR DESCARGA KIT ELEVACIÓN M6 ANTIGUA HASTA 2003	TP438



























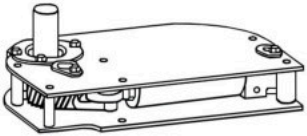
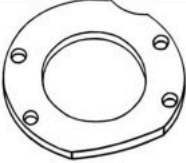
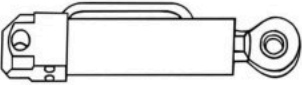
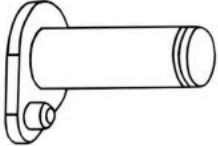
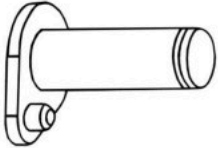
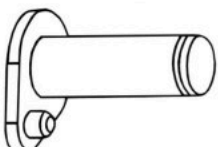
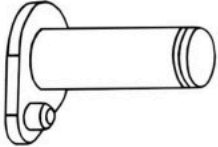
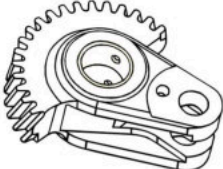
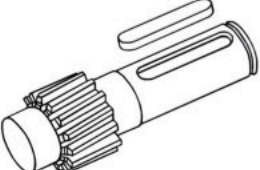

	JUEGO DE JUNTAS CILINDRO CAJA NEGRA	TP055
	JUNTA GOMA VÁSTAGO CAJA NEGRA	TP161
	EMPAQUETADURA PISTÓN CAJA NEGRA	TP290
	JUNTA TÓRICA CAJA NEGRA	TP377
	ARO DURO CAJA NEGRA	TP378
	COLLARÍN CAJA NEGRA	TP379
	RASCADOR METÁLICO CAJA NEGRA	TP380
	JGO DE JUNTAS CILINDRO PINZA VIBRADOR	TP102
	RASCADOR DOBLE FILO CILINDRO PINZA	TP011
	JGO VÁSTAGO CILINDRO PINZA SAMBA+TÓRICA	TP015
	GUÍA RESINA FENÓLICA VÁSTAGO CILINDRO PINZA	TP016
	JGO PISTÓN CILINDRO PINZA SAMBA+TÓRICA	TP017
	GUÍA RESINA FENÓLICA PISTÓN CILINDRO PINZA	TP130
	JUNTA TÓRICA CILINDRO PINZA	TP136
	ARO DURO CILINDRO PINZA	TP137
	JUNTA TÓRICA PISTÓN CILINDRO PINZA	TP197
	JUNTA TÓRICA CILINDRO PINZA	TP199







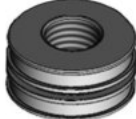

FIGURA	DESCRIPCIÓN	CÓDIGO
1	TUERCA BULÓN KIT ENGANCHE	TP465
2	ARANDELA BULÓN ELEVACIÓN	TP525
3	ARANDELA BULÓN ELEVACIÓN	TP526
4	BULÓN ARTICULACIÓN KIT ENGANCHE	TP406
5	CASQUILLO LISO (UA-30x34x40)	TP304
6	SOPORTE ELEVACIÓN	TP527
7	PASADOR DE SEGURIDAD BARRA ENGANCHE	TP039
8	BARRA ENGANCHE GRANDE (28x39x50 940mm)	TP038
9	BARRA ENGANCHE PEQUEÑA CON OREJETAS (28x35 930mm)	TP037
10	BARRA ENGANCHE PEQUEÑA (30x950mm)	TP037.1
11	BULÓN CILINDRO HIDRÁULICO KIT DE ENGANCHE	TP528
12	CILINDRO ELVACIÓN ENGANCHE	TP179
13	BULÓN KIT ELEVACIÓN	TP264
14	CABEZA GUÍA CILINDRO ENGANCHE	TP182
14	CABEZA GUÍA CILINDRO ENGANCHE MODERNA	TP918
15	PISTÓN CILINDRO ENGANCHE	TP629
15	PISTÓN CILINDRO ENGANCHE MODERNO	TP721
16	CAMISA CILINDRO ENGANCHE	TP180
17	VÁSTAGO CILINDRO ENGANCHE ANTIGUO	TP181
18	VÁSTAGO CILINDRO ENGANCHE MODERNO	TP392
19	CONTRATUERCA PISTÓN	TP630
20	JGO DE RETENES CILINDRO ENGANCHE ANTIGUO	TP184
20	JGO DE RETENES CILINDRO ENGANCHE MODERNO	TP393
21	CONTRATUERCA PISTÓN MODERNO	TP702
22	RÓTULA CILINDRO ELEVACIÓN	TP767

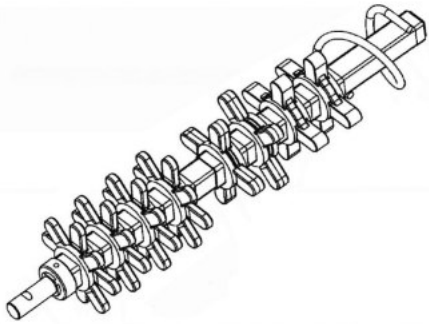
	CAJA NEGRA DERECHA	TP008
	CAJA NEGRA IZQUIERDA	TP009
	CAJA NEGRA DERECHA COMPLETA	TP040
	CAJA NEGRA IZQUIERDA COMPLETA	TP041
	ARANDELA CIERRE RODAMIENTOS CAJA NEGRA	TP035
	CILINDRO CON RÓTULA	TP010
	CILINDRO CAJA NEGRA ANTIGUO	TP042
	TAPÓN 1/4 CILINDRO CAJA NEGRA	TP084
	BULÓN TRASERO CILINDRO 18x70	TP043
	BULÓN RÓTULA 20x51	TP044
	BULÓN CILINDRO ANTIGUO 18x51	TP045
	BULÓN PIÑÓN EXCÉNTRICA 30x70	TP046
	PIÑÓN EXCÉNTRICA RECTO	TP047
	PIÑÓN EXCÉNTRICA HELICOIDAL	TP048
	EJE DE MANDO RECTO	TP 049
	EJE DE MANDO HELICOIDAL	TP050
	CHAVETA PLANA (10x8x60)	TP159

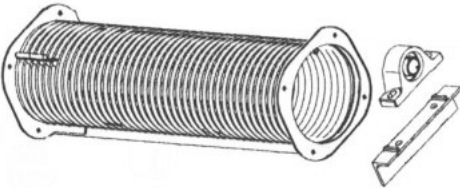
	RODAMIENTO EJE DE MANDO	6207.2RS
	CASQUILLO PARA SOLDAR CAJA NEGRA DIÁMETRO 18mms	TP051
	CASQUILLO PARA SOLDAR CAJA NEGRA DIÁMETRO 30mms	TP052
	CASQUILLO PARA SOLDAR CAJA NEGRA DIÁMETRO 72mms	TP053
	CASQUILLO PISTÓN EXCÉNTRICA (XA-30x25x34)	TP146
	JGO DE JUNTAS CILINDRO CAJA NEGRA	TP055
	JGO DE JUNTAS MODERNO A PARTIR 2015	TP427
	JUNTA PISTÓN 45x37x15.5 (3.2)	TP290
	VÁSTAGO CILINDRO CAJA NEGRA	TP004
	GOMA TÓRICA PARA VÁSTAGO	TP161
	CONTRATUERCA PISTÓN	TP429
	VÁSTAGO CAJA NEGRA ANTIGUO	TP402
	PISTÓN CILINDRO CAJA NEGRA	TP057
	CABEZA GUÍA CILINDRO CAJA NEGRA	TP058

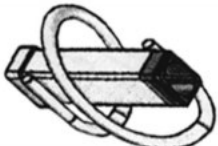
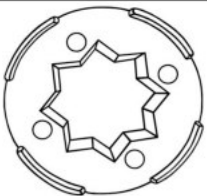
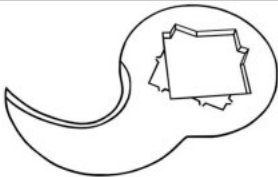
	CILINDRO PINZA VIBRADOR BULÓN DE 25mm	TP096
	CILINDRO PINZA VIBRADOR BULÓN DE 30mm	TP097
	VÁSTAGO CILINDRO HIDRÁULICO BULÓN DE 25mm	TP098
	VÁSTAGO CILINDRO HIDRÁULICO BULÓN DE 30mm	TP099
	CAMISA BULÓN DE 25mm	TP132
	CAMISA BULÓN DE 30mm	TP133
	PISTÓN CILINDRO HIDRÁULICO	TP101
	CONTRATUERCA PISTÓN	TP134
	CABEZA GUÍA CILINDRO HIDRÁULICO	TP100
	JGO DE JUNTAS CILINDRO HIDRÁULICO	TP102
	PLACA DE ALUMINIO	TP173
	EJE DE MANDO	TP034
	TUERCA	TC16
	GOMA SOPORTE MULTIPLICADORA	TP155
	PLACA DE ALUMINIO COMPLETA	TP033
	CHAVETA MEDIA LUNA (4x6.5x16)	TP152
	MANGUITO ESTRIADO	TP028
	RODAMIENTO	6007.2RS
	CHAVETA PLANA (8x7x30)	TP156
	CARDAN TOLVA	TP036
	CHAVETA PLANA (8x7x35)	TP168

	EJE PELADORA COMPLETO	TP225
	EJE PELADORA COMPLETO PLATO ALUMINIO	TP444
	EJE PELADORA DESNUDO ROSCA IZQUIERDA	TP020
	TUERCA EJE PELADORA IZQUIERDA	TP021
	TUERCA EJE PELADORA DERECHA	TP059
	ESPIRAL ALIMENTACIÓN M6	TP160
	RODAMIENTO PEQUEÑO EJE PELADORA	TP202
	ESPIRAL PELADORA	TP061
	RODAMIENTO	TP128
	RODAMIENTO ECONÓMICO	TP128.1
	RODAMIENTO CON SOPORTE EJE PELADORA	TP062
	SOPORTE SUJECCIÓN RODAMIENTO	TP464
	SOPORTE SIN FÍN LLENADO TOLVA	TP063
	CASQUILLO CON VALONA (20x21.5x20)	TP064
	ESPIRAL ALIMENTACIÓN PV	TP162
	PLATO ALUMINIO PELADORA	TP066
	PLATO NYLON PELADORA	TP067
	CUCHILLA GANCHO PELADORA "I"	TP389
	CUCHILLA GANCHO PELADORA PV "D"	TP442
	GOMA PELADORA MUY BLANDA CHICLE	TP007C
	GOMA PELADORA BLANDA	TP007B
	GOMA PELADORA DURA	TP007
	GOMA PELADORA DE LONA	TP007L
	PELADORA DE CHAPA	TP195
	GOMA PELADORA DOBLE	TP068



FIGURA	DESCRIPCIÓN	CÓDIGO
1	TIRANTE VIBRADOR 150mm	TP013
2	PINZA DERECHA VIBRADOR	TP075
3	PINZA IZQUIERDA VIBRADOR	TP076
4	MOTOR VIBRADOR IZQUIERDO	TP077
5	TACO DE GOMA 100x75	TP012
6	CASQUILLO BISAGRA PINZA 80x85x12.3	TP079
6	CASQUILLO BISAGRA PINZA 80x85x20	TP080
7	CASQUILLO BISAGRA PINZA 80x85x80	TP081
8	BUJE BISAGRA ANTIGUO 80x107.5	TP001
8	BUJE BISAGRA MODERNO 80x123.5	TP002
9	TUERCA SILENTBLOCK	T16
10	BRIDA MOTOR	TP082
11	BRIDA MOTOR	TP083
12	MOTOR DERECHO	TP078
13	PLATO EXCÉNTRICA SUPERIOR	TP074
14	EJE ACOPLAMIENTO MOTOR PESA	TP085
14	EJE ACOPLAMIENTO MOTOR PESA DOBLE CHAVETERO	TP085.1
14	EJE ACOPLAMIENTO MOTOR PESA TEMPLADO	TP204
15	CHAVETA EJE PESA 8x7x25	TP086
15	CHAVETA MOTOR 4x20	TP087
16	RODAMIENTO PESA	TP193
17	PESA VIBRADOR	TP088
18	PLATO EXCÉNTRICA INFERIOR	TP073
19	FALDILLA PROTECTOR MAZO	TP089
19	FALDILLA CAMELO PROTECTOR MAZO	TP400



FIGURA	DESCRIPCIÓN	CÓDIGO
20	FALDILLA MAZO VIBRADOR	TP090
20	FALDILLA CAMELO BRAZO VIBRADOR	TP399
21	MAZO VIBRADOR M6 BLANDO	TP396
21	MAZO VIBRADOR M6 200x500x50	TP397
21	MAZO VIBRADOR M6 480x140x16	TP091
22	BULÓN CILINDRO HIDRÁULICO 25mm	TP092
22	BULÓN CILINDRO HIDRÁULICO 30mm	TP093
23	CASQUILLO BULÓN 25x28x30	TP005
23	CASQUILLO BULÓN 30x34x30	TP094
24	MACHÓN 11/16 ORFS - 3/8 GAS	TP095
25	CILINDRO PINZA VIBRADOR ANTIGUO BULÓN 25mm	TP096
25	CILINDRO PINZA VIBRADOR MODERNO BULÓN 30mm	TP097
26	VÁSTAGO CILINDRO HIDRÁULICO ANTIGUO BULÓN 25mm	TP098
26	VÁSTAGO CILINDRO HIDRÁULICO MODERNO BULÓN 30mm	TP099
27	CABEZA GUÍA CILINDRO HIDRÁULICO	TP100
28	PISTÓN CILINDRO HIDRÁULICO	TP101
29	JUEGO DE JUNTAS CILINDRO HIDRÁULICO	TP102
29	JUEGO DE JUNTAS CILINDRO HIDRÁULICO ANTIGUO	TP211
30	CASQUILLO TIRANTE VIBRADOR	TP103
31	REFUERZO PINZA TIJERA 100mm	TP104
31	REFUERZO PINZA TIJERA 95mm	TP446
32	TORNILLO 12x70 10.9	TP105
33	CHAPA SEGURIDAD BULÓN 25mm	TP106
33	CHAPA SEGURIDAD BULÓN 30mm	TP107
34	CASQUILLO VÁSTAGO BULÓN 25mm	TP466
34	CASQUILLO VÁSTAGO BULÓN 30mm	TP196

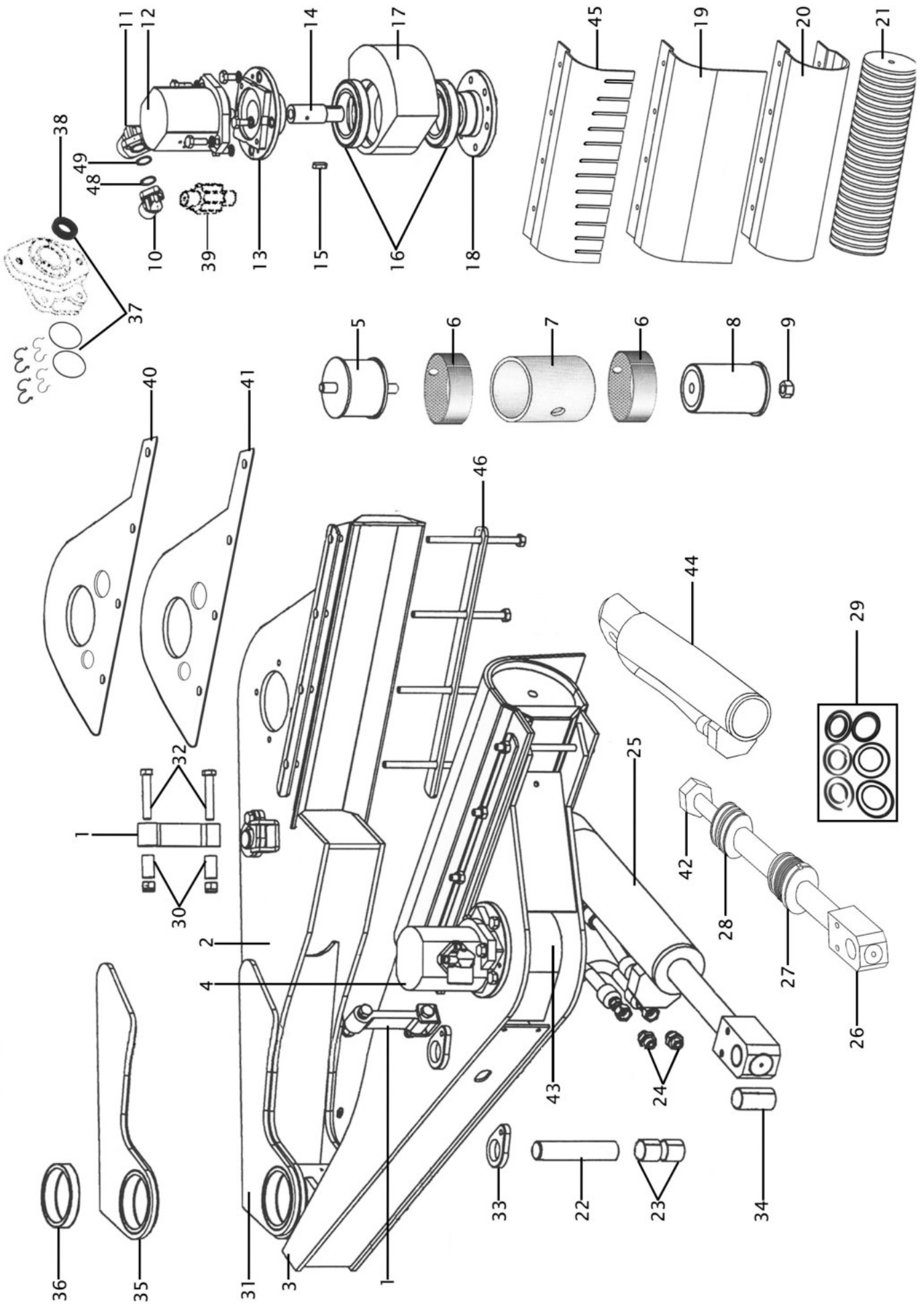

FIGURA	DESCRIPCIÓN	CÓDIGO
35	OREJETAS REPARACIÓN PINZA 100mm	TP324
36	CASQUILLO PARA SOLDAR PINZA CORTO (ANTIGUO)	TP003
36	CASQUILLO PARA SOLDAR PINZA LARGO (MODERNO)	TP131
37	JUEGO DE JUNTAS MOTOR VIBRADOR	TP157
38	RETÉN MOTOR HIDRÁULICO	TP228
39	EJE MOTOR HIDRÁULICO	TP289
40	REFUERZO PLATO EXCÉNTRICA SUPERIOR	TP327
41	REFUERZO PLATO EXCÉNTRICA INFERIOR	TP326
42	CONTRATUERCA PISTÓN	TP134
43	TAPAS EXCÉNTRICA VIBRADOR M6	TP374
44	CAMISA BULÓN DE 25mm	TP132
44	CAMISA BULÓN DE 30mm	TP133
45	SUPLEMENTO CON DEDOS MAZO	TP398
46	PLETINA SUJECCIÓN FALDILLAS VIBRADOR	TP440
47	TORNILLO 10x160 8.8	TP529
48	GOMA TÓRICA VITÓN BRIDA	TP599
49	GOMA TÓRICA VITÓN BRIDA	TP623

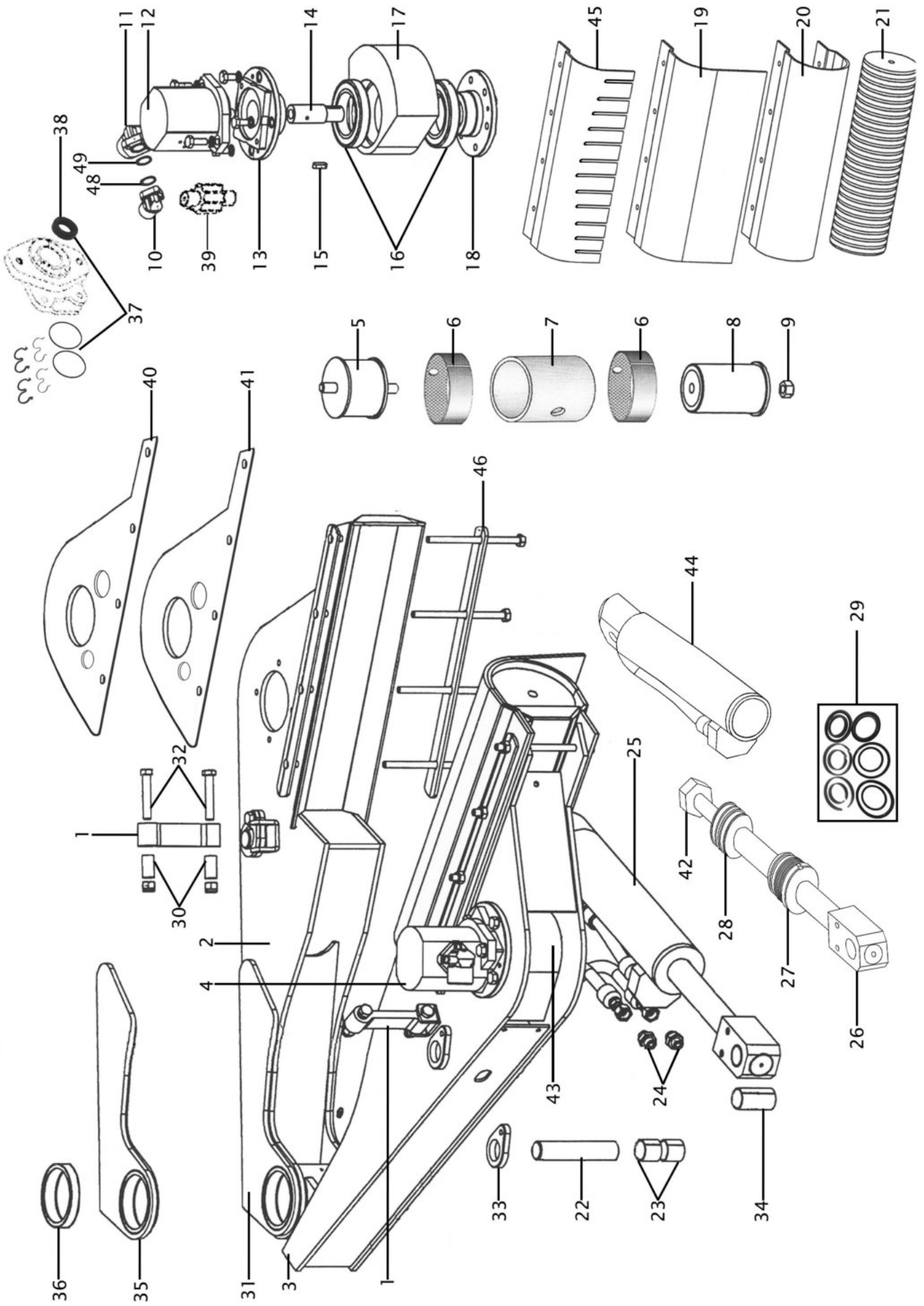

FIGURA	DESCRIPCIÓN	CÓDIGO
1	PLATO EXCÉNTRICA SUPERIOR	TP243
2	EJE ACOPLAMIENTO MOTOR PESA ESTRIADO	TP244
3	CHAVETA PLANA EJE PESA 8x7x25	TP086
4	RODAMIENTO PESA	TP193
5	PESA VIBRADOR	TP088
6	PLATO EXCÉNTRICA INFERIOR	TP073
7	VÁSTAGO CILINDRO HIDRÁULICO 30mm	TP099
8	CILINDRO PINZA VIBRADOR BULÓN 30mm	TP097
9	ARANDELA CIERRE BUJE	TP245
10	CASQUILLO BISAGRA PINZA 80x85x80	TP081
11	CASQUILLO BISAGRA PINZA 80x85x20	TP080
12	CASQUILLO BULÓN 30x34x30	TP094
13	BULÓN CILINDRO HIDRÁULICO 30mm	TP093
14	CHAPA DE SEGURIDAD BULÓN 30mm	TP107
15	BUJE BISAGRA PINZA	TP246
16	TACO DE GOMA MODERNO	TP012.1
17	ESLINGA VIBRADOR	TP013
18	CASQUILLO TIRANTE VIBRADOR	TP103
19	TORNILLOS DE 12x70 10.9	TP105
20	MACHONES MOTOR VIVOLO	TP247
21	OREJETAS REPARACIÓN PINZA 100mm	TP324
22	REFUERZO PINZA VIBRADOR 95mm	TP104
22	BRIDA MOTOR 1"	TP231
23	MOTOR GALTECH PELADORA 2010 32cm <sup>3</sup>	TP191
23	MOTOR SALAMI PELADORA 2010 43cm <sup>3</sup>	TP532

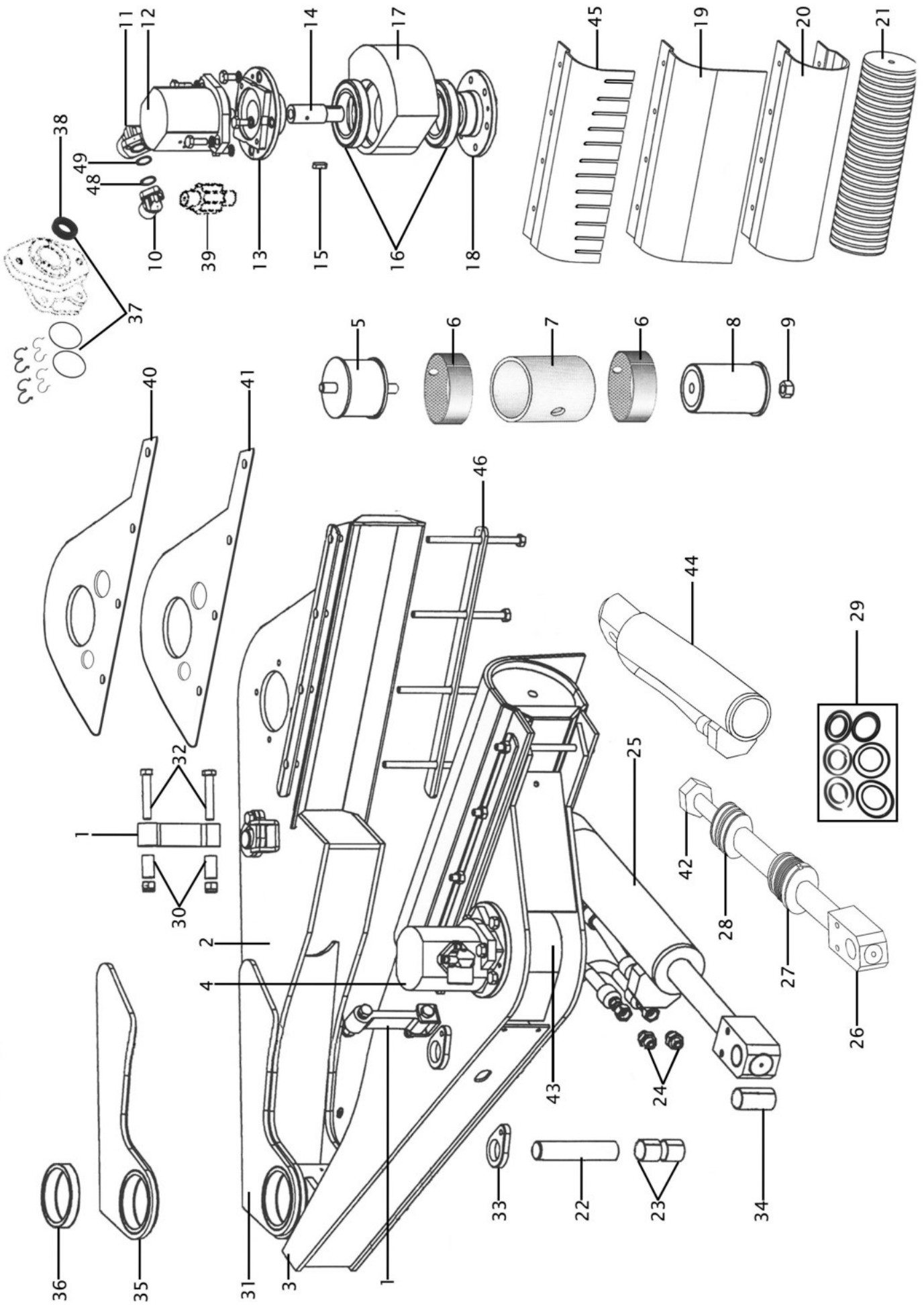

FIGURA	DESCRIPCIÓN	CÓDIGO
24	REGISTRO MOTOR	TP250
25	PINZA DERECHA VIBRADOR	TP075
26	PINZA IZQUIERDA VIBRADOR	TP076
27	FALDILLA PROTECTOR MAZO VIBRADOR	TP089
27	FALDILLA CARAMELO PROTECTOR MAZO VIBRADOR	TP400
27	FALDILLA MAZO VIBRADOR	TP090
27	FALDILLA CARAMELO MAZO VIBRADOR	TP399
28	FALDILLA MAZO VIBRADOR	TP090
28	FALDILLA CARAMELO MAZO VIBRADOR	TP399
28	FALDILLA PARA MAZO VIBRADOR PROFESIONAL	TP183
28	FALDILLA CARAMELO PARA MAZO VIBRADOR PROFESIONAL	TP225
29	MAZO VIBRADOR	TP091
30	BRIDA MOTOR 3/4	TP249
31	REFUERZO PLATO EXCÉNTRICA INFERIOR	TP326
32	REFUERZO PLATO EXCÉNTRICA SUPERIOR	TP369
33	TORNILLO CIERRE ARANDELA BUJE 2010	TP335
34	JGO REPARACIÓN MOTOR GALTECH PELADORA 2010	TP333
34	JGO REPARACIÓN MOTOR SALAMI PELADORA 2010	TP531
34	JGO REPARACIÓN MOTOR VIVOLO PELADORA 2010	TP530
35	CABEZA GUÍA CILINDRO HIDRÁULICO	TP100
36	PISTÓN CILINDRO HIDRÁULICO	TP101
37	CONTRATUERCA PISTÓN	TP134
38	CAMISA CILINDRO HIDRÁULICO BULÓN 30mm	TP133
39	JGO DE JUNTAS CILINDRO HIDRÁULICO	TP102



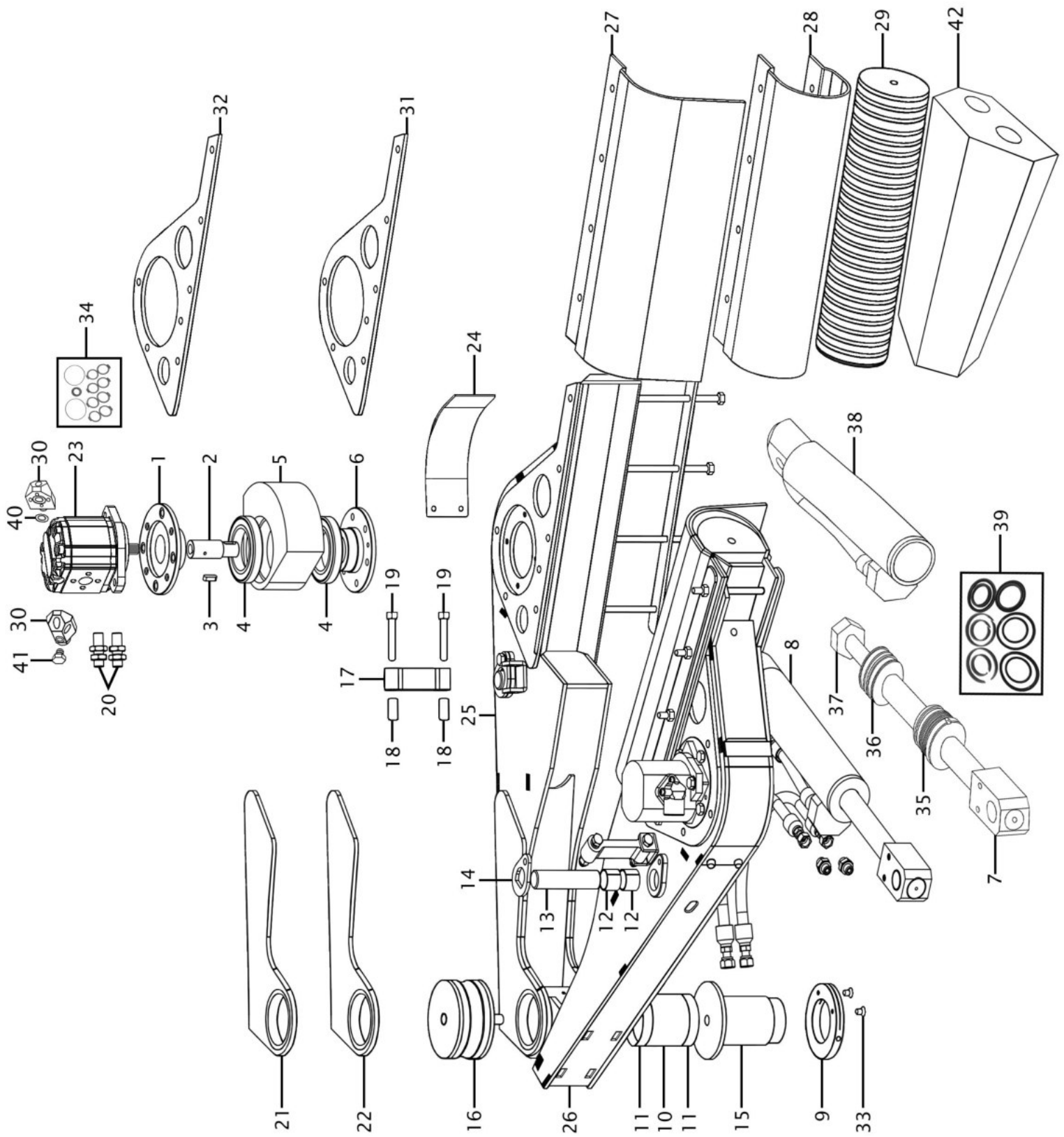



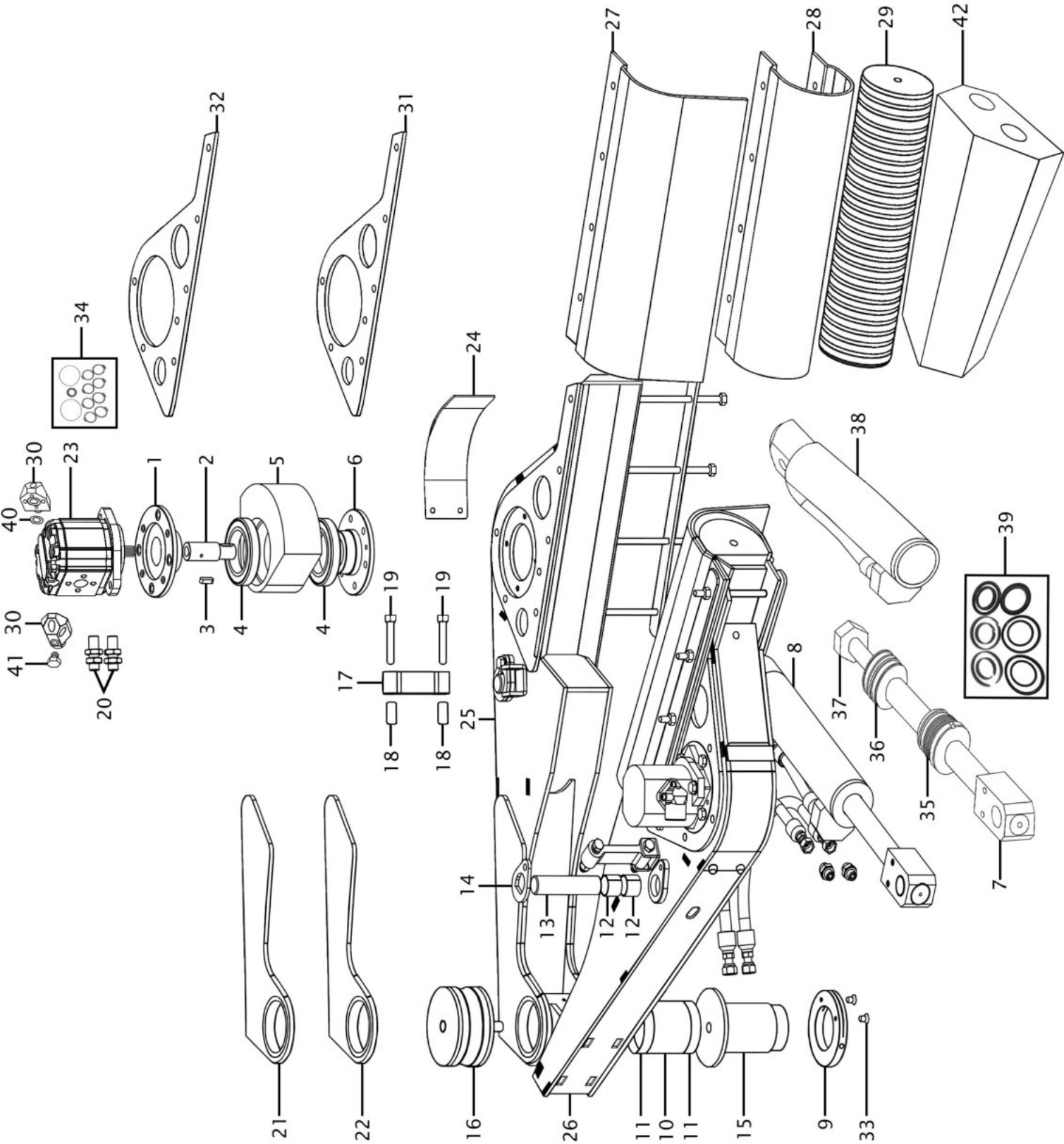
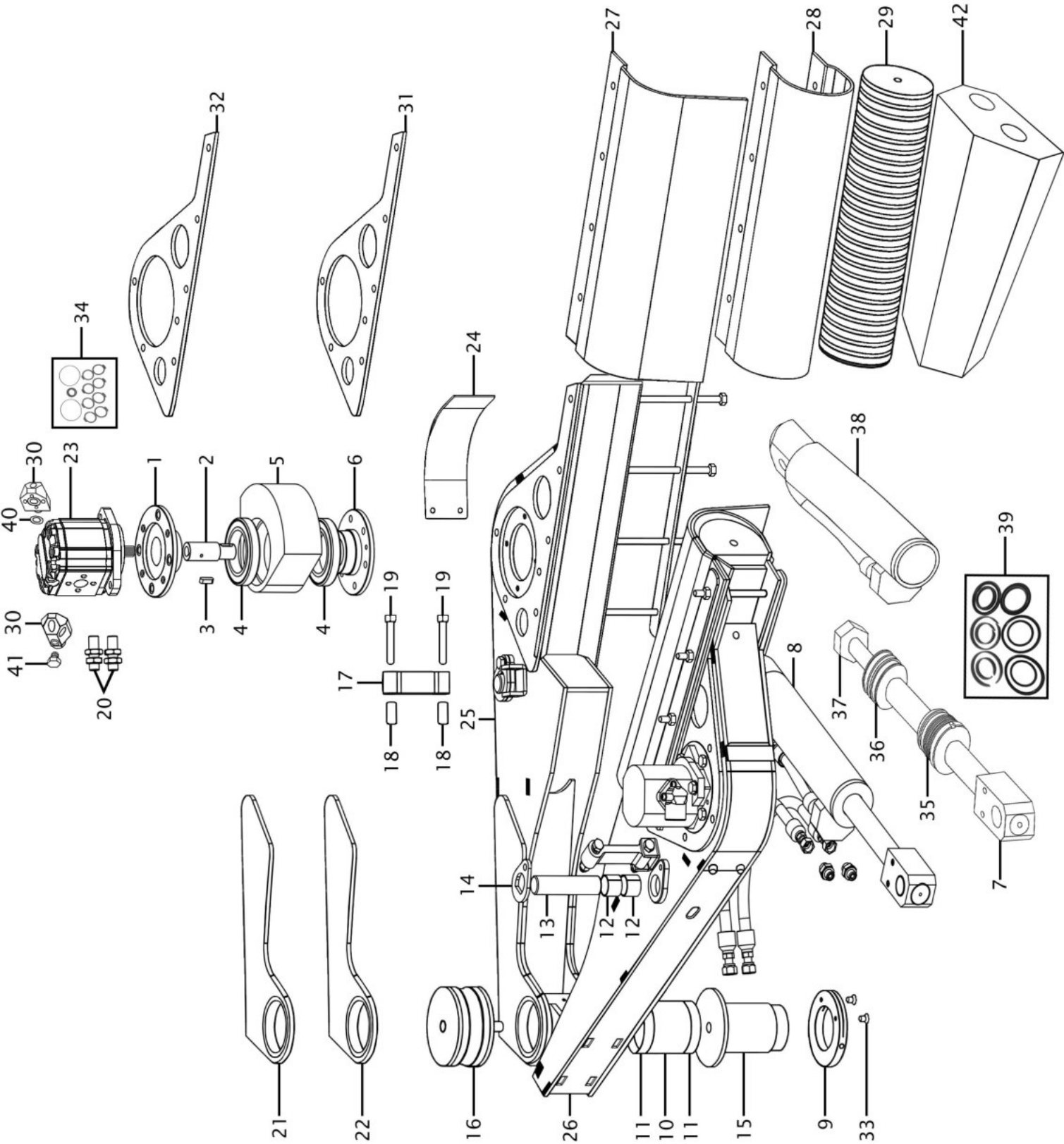







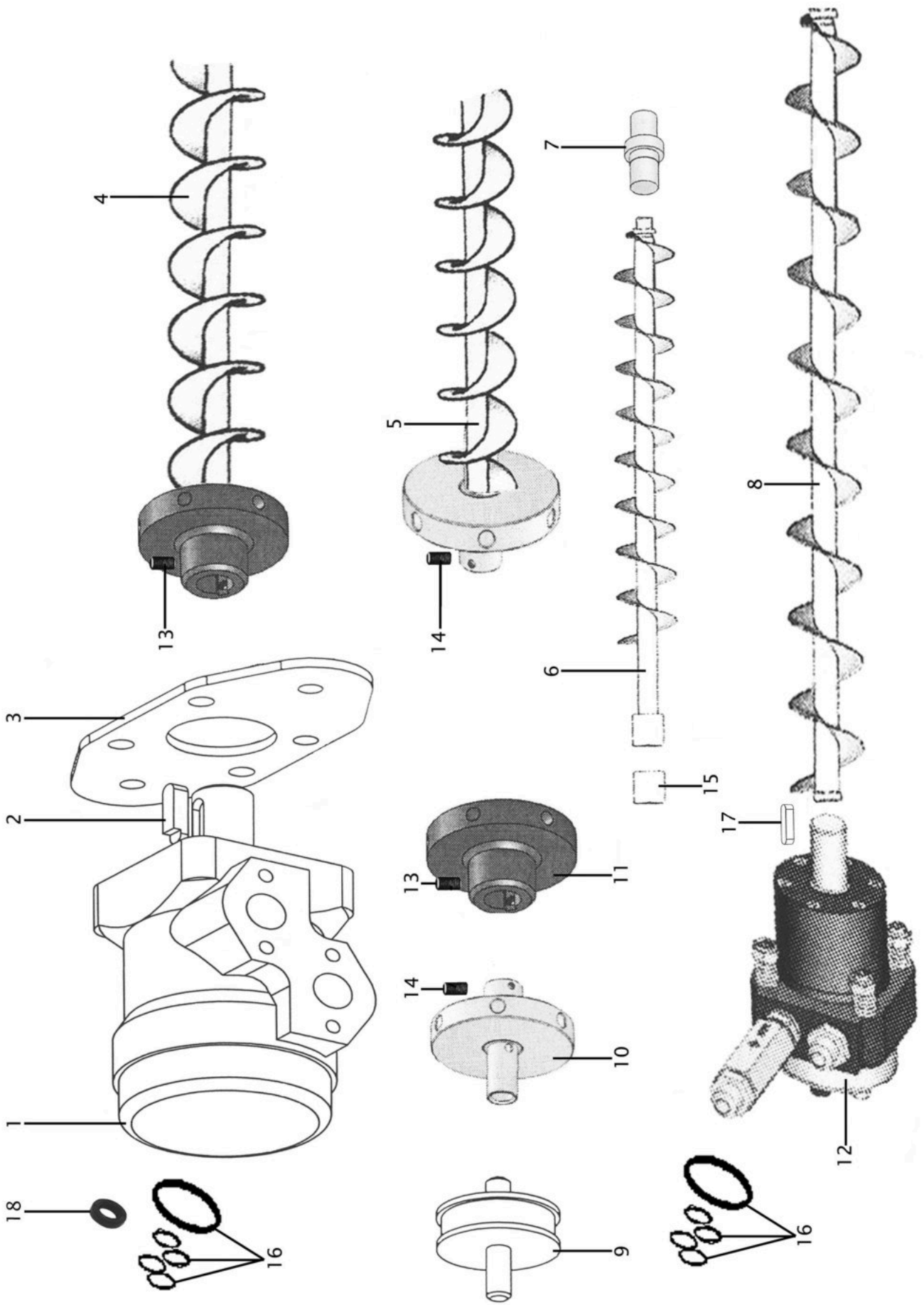
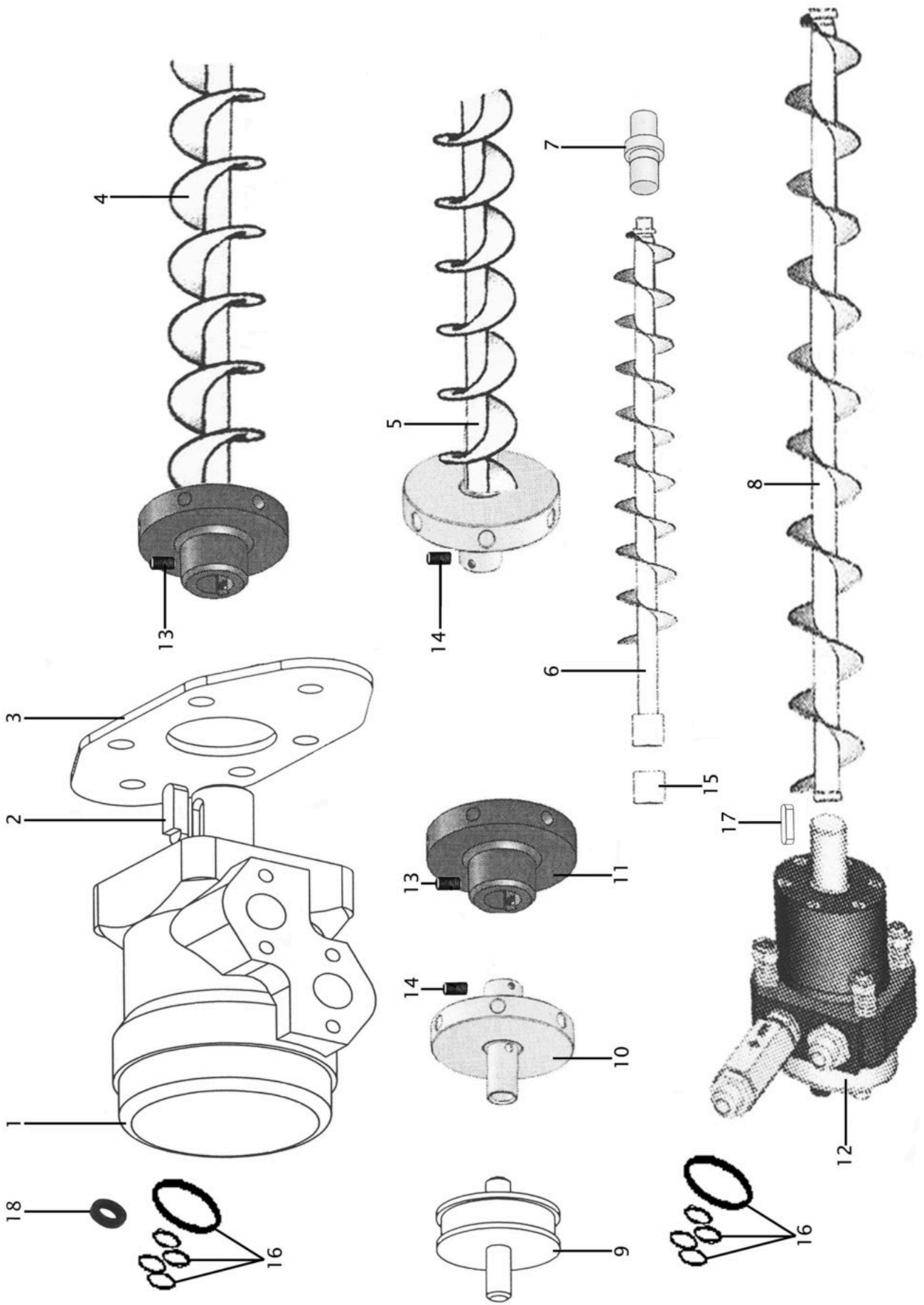
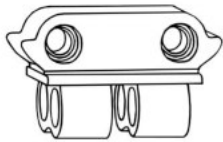
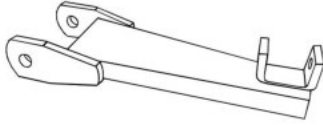





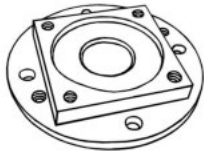

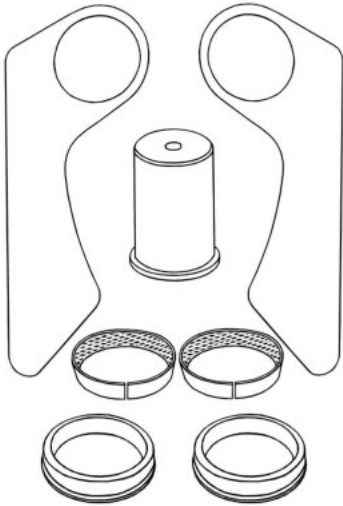
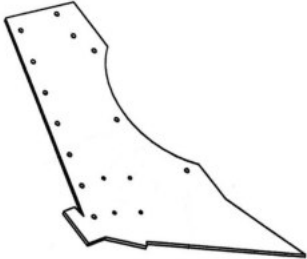

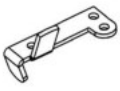



FIGURA	DESCRIPCIÓN	CÓDIGO
1	MOTOR HIDRÁULICO EJE 16mm	TP108
1	MOTOR HIDRÁULICO EJE 25mm	TP109
2	CHAVETA MOTOR HIDRÁULICO EJE 16mm	TP110
2	CHAVETA MOTOR HIDRÁULICO EJE 25mm	TP111
3	TAPADERA MOTOR HIDRÁULICO PEQUEÑO	TP112
3	TAPADERA MOTOR HIDRÁULICO GRANDE	TP113
4	SINFÍN ALIMENTACIÓN PELADORA DCHO ROSCA IZQ EJE 25mm	TP114
4	SINFÍN ALIMENTACIÓN PELADORA IZQ ROSCA DCHA EJE 25mm	TP115
5	SINFÍN ALIMENTACIÓN PELADORA DCHO ROSCA IZQ EJE 16mm	TP116
5	SINFÍN ALIMENTACIÓN PELADORA IZQ ROSCA DCHA EJE 16mm	TP117
6	SINFÍN LLENADO TOLVA DERECHO PARA EJE 16mm	TP118
6	SINFÍN LLENADO TOLVA IZQUIERDO PARA EJE 16mm	TP119
6	SINFÍN LLENADO TOLVA DERECHO PARA EJE 25mm	TP120
6	SINFÍN LLENADO TOLVA IZQUIERDO PARA EJE 25mm	TP121
7	PUNTA SINFÍN LLENADO TOLVA	TP122
8	SINFÍN DESCARGA TOLVA	TP123
9	SILENTBLOCK PARA MOTOR EJE 16mm	TP300
9	SILENTBLOCK PARA MOTOR EJE 25mm	TP124
10	PLATILLO GIRO SINFÍN PARA EJE 16mm	TP125
11	PLATILLO GIRO SINFÍN PARA EJE 25mm	TP126
12	MOTOR HIDRÁULICO DESCARGA TOLVA	TP127
13	PRISIONERO DE 8mm	TP022
14	PRISIONERO DE 6mm	TP065
15	CASQUILLO SINFÍN EJE 16mm	TP205

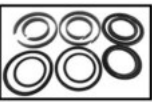



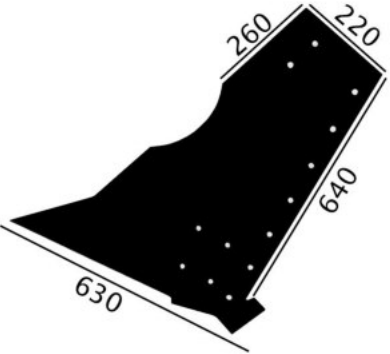

	SOPORTE PAJARITO DESNUDO	TP194
	SOPORTE PAJARITO COMPLETO	TP069
	BRAZO DERECHO	TP070
	BRAZO IZQUIERDO	TP071
	TIRANTE VIBRADOR 150mm	TP013
	CASQUILLO TIRANTE VIBRADOR	TP103
	TORNILLO 16x130 10.9	TP072
	RÓTULA	TP023
	CASQUILLO RÓTULA	TP024
	SILENTBLOCK 20x45x64	TP025
	PLATO EXCÉNTRICA INFERIOR	TP073
	PLATO EXCÉNTRICA SUPERIOR	TP074
	RODAMIENTO TAPA EXCÉNTRICA	TP193
	KIT REFUERZO M6 PINZA TIJERA	TP445

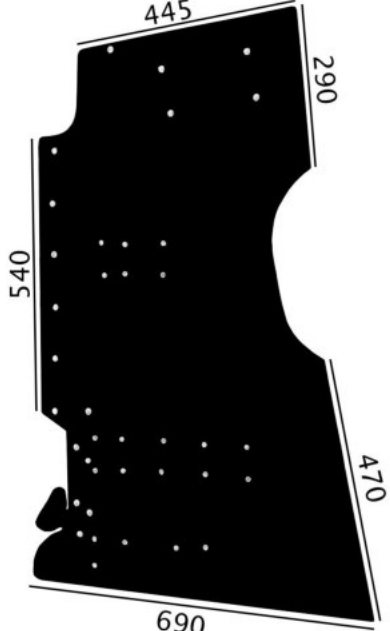
	FALDILLA CIERRE TRONCO	TP056
	PLETINA ELEVACIÓN	TP169
	PLETINA ELEVACIÓN PV	TP747
	PLETINA ELEVACIÓN DERECHA	TP170
	PLETINA ELEVACIÓN IZQUIERDA	TP171
	PLETINA ELEVACIÓN DERECHA PV	TP745
	PLETINA ELEVACIÓN IZQUIERDA PV	TP746
	PLETINA ELEVACIÓN	TP172
	PLETINA ELEVACIÓN	TP441
	CASQUILLO CON VALONA (UB-30x26)	TP135
	CASQUILLO (30x34x30)	TP094
	CILINDRO PINZA VIBRADOR ANTIGUO	TP185
	CAMISA CILINDRO VIBRADOR ANTIGUO	TP186
	VÁSTAGO CILINDRO PINZA VIBRADOR ANTIGUO	TP187
	CABEZA GUÍA CILINDRO VIBRADOR ANTIGUO	TP188
	PISTÓN CILINDRO VIBRADOR ANTIGUO	TP189
	JGO DE RETENES CILINDRO VIBRADOR ANTIGUO	TP190
	FLECTOR TRANSMISIÓN M5	TP390

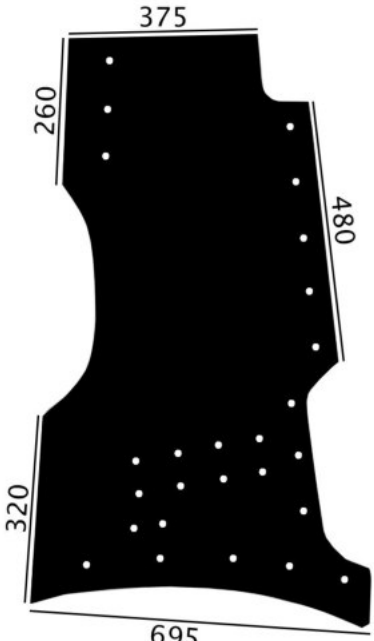
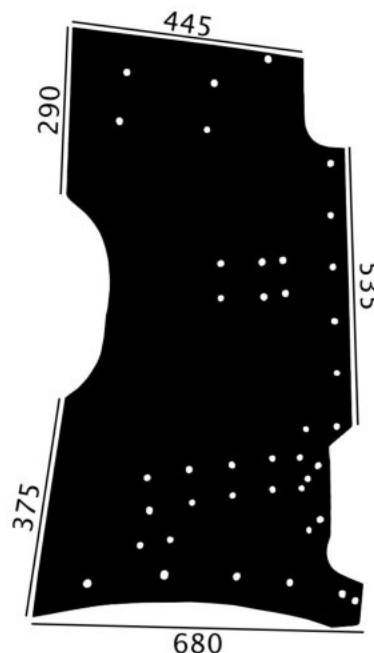
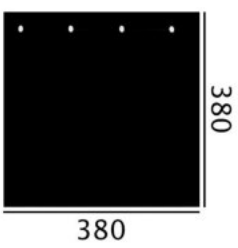

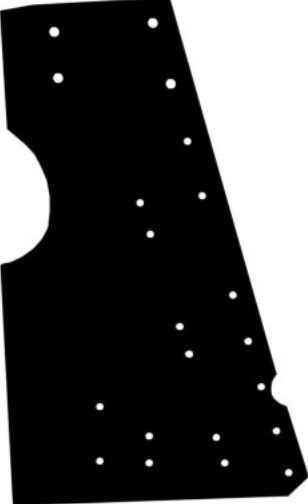
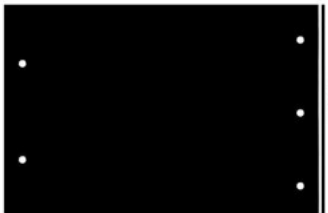
	<p>GOMA CIERRE TRONCO</p>	<p>TP056</p>
	<p>FALDILLA PROTECTOR MAZO</p>	<p>TP089</p>
	<p>FALDILLA CARAMELO PROTECTOR MAZO</p>	<p>TP400</p>
	<p>FALDILLA MAZO VIBRADOR</p>	<p>TP090</p>
	<p>FALDILLA CARAMELO MAZO VIBRADOR</p>	<p>TP399</p>
	<p>FALDILLA TACO LATERAL PINZA TENAZA</p>	<p>TP210</p>
	<p>FALDILLA CARAMELO TACO LATERAL TENAZA</p>	<p>TP250</p>
	<p>FALDILLA FIELTRO TACO LATERAL TENAZA</p>	<p>TP462</p>
	<p>GOMA CIERRE TRONCO PV CON TRÉBOL</p>	<p>TP226</p>

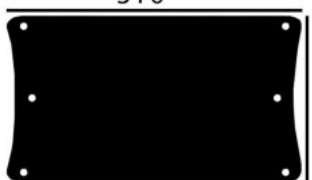
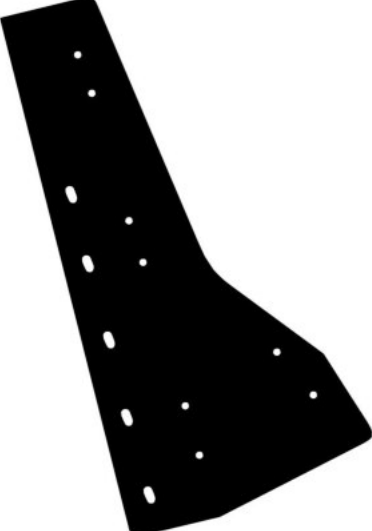



	<p>GOMA CIERRE TRONCO PV ANTIGUA 5 AGUJEROS</p>	<p>TP227</p>
	<p>GOMA CIERRE TRONCO PV ANTIGUA 6 AGUJEROS</p>	<p>TP376</p>
	<p>FALDILLA TACO FRONTAL PINZA TENAZA</p>	<p>TP291</p>
	<p>FALDILLA CAMELO FRONTAL PINZA TENAZA</p>	<p>TP401</p>
	<p>FALDILLA FIELTRO FRONTAL PINZA TENAZA</p>	<p>TP463</p>

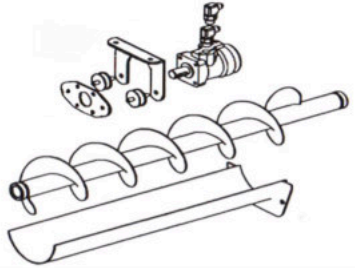
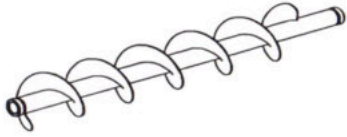
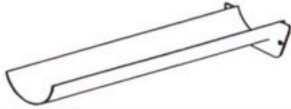
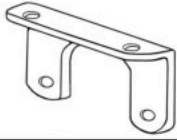

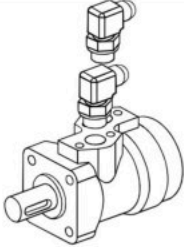
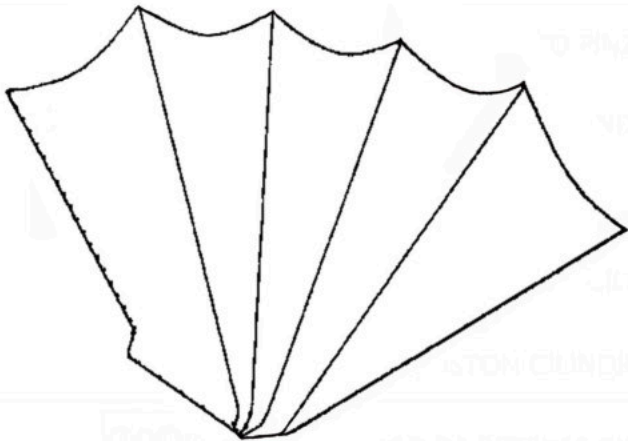









	<p>FALDILLA CIERRE TRONCO M6 PRO</p>	<p>TP927</p>
	<p>FALDILLA CUBRE MAZO M6 PRO</p>	<p>TP928</p>
	<p>FALDILLA ABRAZA MAZO M6 PRO</p>	<p>TP929</p>
	<p>FALDILLA TACO FRONTAL M6 PRO</p>	<p>TP931</p>
	<p>FALDILLA CARAMELO TACO FRONTAL M6 PRO</p>	<p>TP933</p>
	<p>FALDILLA GOMA CIERRE TRONCO INTERIOR M6 PRO</p>	<p>TP930</p>

	<p>GOMA CIERRE TRONCO M6</p>	<p>TP312</p>
	<p>FALDILLA CON FLECOS MAZO M6</p>	<p>TP398</p>
	<p>SILENTBLOCK VIBRADOR TENAZA (140x225)</p>	<p>TP235</p>
	<p>SILENTBLOCK VIBRADOR TENAZA (140x270)</p>	<p>TP347</p>
	<p>SILENTBLOCK VIBRADOR TENAZA (100x220)</p>	<p>TP331</p>
	<p>SILENTBLOCK VIBRADOR TENAZA (100x180)</p>	<p>TP236</p>
	<p>SILENTBLOCK PINZA TENAZA (295x180x60)</p>	<p>TP254</p>
	<p>SILENTBLOCK PINZA TENAZA BLANDO (310x180x60)</p>	<p>TP292</p>
	<p>SILENTBLOCK PINZA TENAZA (355x180x60)</p>	<p>TP167</p>
	<p>SILENTBLOCK PINZA TENAZA BLANDO (355x180x60)</p>	<p>TP295</p>
	<p>SILENTBLOCK TOPE PINZA TENAZA DURO</p>	<p>TP722</p>
	<p>SILENTBLOCK TOPE PINZA TENAZA BLANDO</p>	<p>TP278</p>
	<p>SILENTBLOCK TOPE PINZA TENAZA MUY BLANDO</p>	<p>TP060</p>

	RADIO N°2 CORTO A PARTIR DE CAJA NEGRA	TP174
	RADIO N°3 A PARTIR DE CAJA NEGRA	TP175
	RADIO N°4-N°5 A PARTIR DE CAJA NEGRA	TP176
	TUERCA REMACHABLE DE 8mm	TP271
	TUERCA REMACHABLE DE 10mm	TP272
	BARRA RADIOS DERECHA	TP269
	BARRA RADIOS IZQUIERDA	TP270
	TAPÓN BARRA RADIOS 35mm	TP318
	TAPÓN BARRA RADIOS 40mm	TP287
	TAPÓN BARRA RADIOS 45mm	TP288
	CASQUILLO BARRA RADIOS	TP319
	BARRA RADIO N°2	TP905
	BARRA RADIO N°3	TP906
	BARRA RADIO N°4	TP907
	BARRA RADIO N°5	TP908
	GOMA TOPE RADIO NORMAL PARA RADIO N°3 N°4 N°5	TP802
	GOMA TOPE RADIO LARGA PARA RADIO N°2	
	MANGUITO PROTECTOR TOLDO CORTO (45x550mms)	TP297
	MANGUITO PROTECTOR TOLDO LARGO (45x600mms)	TP298 TP801
	GOMA RIZADA REFUERZO CENTRAL	TP371
	GOMA RIZADA SIN REFUERZO	TP299
	GOMA RIZADA SOLANO	TP372
	CORDÓN ELÁSTICO DE 8mm	TP223
	CORDÓN ELÁSTICO DE 9mm	TP268
	CORDÓN ELÁSTICO DE 10mm	TP224

	<p>KIT DE ACEITUNA</p>	<p>TP258</p>
	<p>SINFÍN KIT DE ACEITUNA</p>	<p>TP282</p>
	<p>CANALETA KIT DE ACEITUNA</p>	<p>TP283</p>
	<p>SOPORTE MOTOR KIT ACEITUNA</p>	<p>TP284</p>
	<p>TAPADERA MOTOR HIDRÁULICO 16mm</p>	<p>TP112</p>
	<p>TAPADERA MOTOR HIDRÁULICO 25mm</p>	<p>TP113</p>
	<p>SILEMBLOCK MOTOR SINFIN EJE 16mm</p>	<p>TP300</p>
	<p>SILEMBLOCK MOTOR SINFIN EJE 25mm</p>	<p>TP124</p>
	<p>CODO ORIENTABLE 1/2 GAS A 3/4 JIC</p>	<p>TP285</p>
	<p>MOTOR HIDRÁULICO</p>	<p>TP109</p>
 <p>TOLDO</p>		<p>TP286</p>

	CASQUILLO CON VALONA SINFIN LLENADO TOLVA (UB-20x21.5x20)	TP064
	CASQUILLO CON VALONA RADIOS (UB-30x34x26)	TP135
	CASQUILLO LISO VASTAGO ANTIGUO (UA-18x15x20)	TP375
	CASQUILLO LISO (UA-30x34x30)	TP094
	CASQUILLO LISO (UA-30x34x40)	TP034
	CASQUILLO LISO (UA-35x35x39)	TP345
	CASQUILLO DE BRONCE CON ALVÉOLOS (SBA-25x30x28)	TP142
	CASQUILLO DE BRONCE CON ALVÉOLOS (SBA-30x20x34)	TP144
	CASQUILLO DE BRONCE CON ALVÉOLOS (SBA-30x25x34)	TP373
	CASQUILLO DE BRONCE CON ALVÉOLOS (SBA-30x30x34)	TP143
	CASQUILLO DE BRONCE CON ALVÉOLOS (SBA-30x40x34)	TP141
	CASQUILLO DE BRONCE CON ALVÉOLOS (SBA-35x35x39)	TP505
	CASQUILLO DE BRONCE CON ALVÉOLOS (SBA-35x40x39)	TP139
	CASQUILLO DE BRONCE CON ALVÉOLOS (SBA-35x50x39)	TP138
	CASQUILLO DE BRONCE CON ALVÉOLOS (SBA-50x60x55)	TP418
	CASQUILLO DE ACERO CON ALVÉOLOS (XA-25x20x28)	TP387
	CASQUILLO DE ACERO CON ALVÉOLOS (XA-25x25x28)	TP388
	CASQUILLO DE ACERO CON ALVÉOLOS (XA-25x30x30)	TP006
	CASQUILLO DE ACERO CON ALVÉOLOS (XA-30x25x34)	TP146
	CASQUILLO DE ACERO CON ALVÉOLOS (XA-35x30x39)	TP140
	CASQUILLO DE ACERO CON ALVÉOLOS (XA-40x30x34)	TP334
	CASQUILLO DE ACERO CON ALVÉOLOS (XA-50x50x55)	TP413

	CHAVETA MEDIA LUNA BOMBA HIDRÁULICA (4x7.5x19)	TP148
	CHAVETA MEDIA LUNA PLACA ALUMINIO (4x6.5x16)	TP152
	CHAVETA PLANA MOTOR PESA (4x4x20)	TP087
	CHAVETA PLANA MOTOR HIDRÁULICO EJE 16 mm (5x5x16)	TP110
	CHAVETA PLANA (8x7x20)	TP154
	CHAVETA PLANA EJE PESA (8x7x25)	TP086
	CHAVETA PLANA CÁRDAN TOLVA (8x7x30)	TP156
	CHAVETA PLANA MOTOR DESCARGA TOLVA (8x7x32)	TP158
	CHAVETA PLANA CÁRDAN TOLVA (8x7x35)	TP168
	CHAVETA PLANA PARA EJE RADIOS (10x8x60)	TP159
	CHAVETA CON REBAJE PARA PRISIONEROS (8x7x32)	TP111
	CHAVETA PELADORA PV MECANIZADA (6,3x6,3x25,3)	TP748

PINZA TIJERA



FIGURA	DESCRIPCIÓN	CÓDIGO
1	BULÓN BISAGRA VIBRADOR TIJERA	TP508
2	CASQUILLO AUTOLUBRICADO 60x74x35	TP511
3	CASQUILLO AUTOLUBRICADO 60x75x50	TP517
4	CASQUILLO BULÓN CILINDRO PINZA 35x35	TP505
5	BULÓN LARGO CILINDRO PINZA 197x35	TP416
6	CHAPA BULÓN CILINDRO PINZA	TP417
7	TORNILLO 10x20-10.9	TP510
8	ENGRASADOR RECTO 8x125	TP512
9	BULÓN CORTO CILINDRO PINZA	TP415
10	TORNILLO 16x35-10.9	TP509
11	PRISIONERO 8x10	TP514
12	TORNILLO 16x220-10.9	TP520
13	MAZO VIBRADRO DURO	TP091
13	MAZO VIBRADOR BLANDO	TP396
14	TUERCA DE FRENO DE 16	TP521
15	CHAVETA EJE EXCÉNTRICA	TP473
16	TORNILLO ALLEN 16x70-12.9	TP518
17	ANILLO ELÁSTICO	TP470
18	ARANDELA SUJECCIÓN RETÉN	TP469
19	RETÉN VIBRADOR	TP468
20	RODAMIENTO VIBRADOR	TP467
21	ENGRASADOR RECTO 6x100	TP513
22	TORNILLO ALLEN CÓNICO 16x30-10.9	TP487
23	MOTOR HIDRÁULICO	TP482
24	ARANDELA METAL GOMA 1"	TP523

PINZA TIJERA

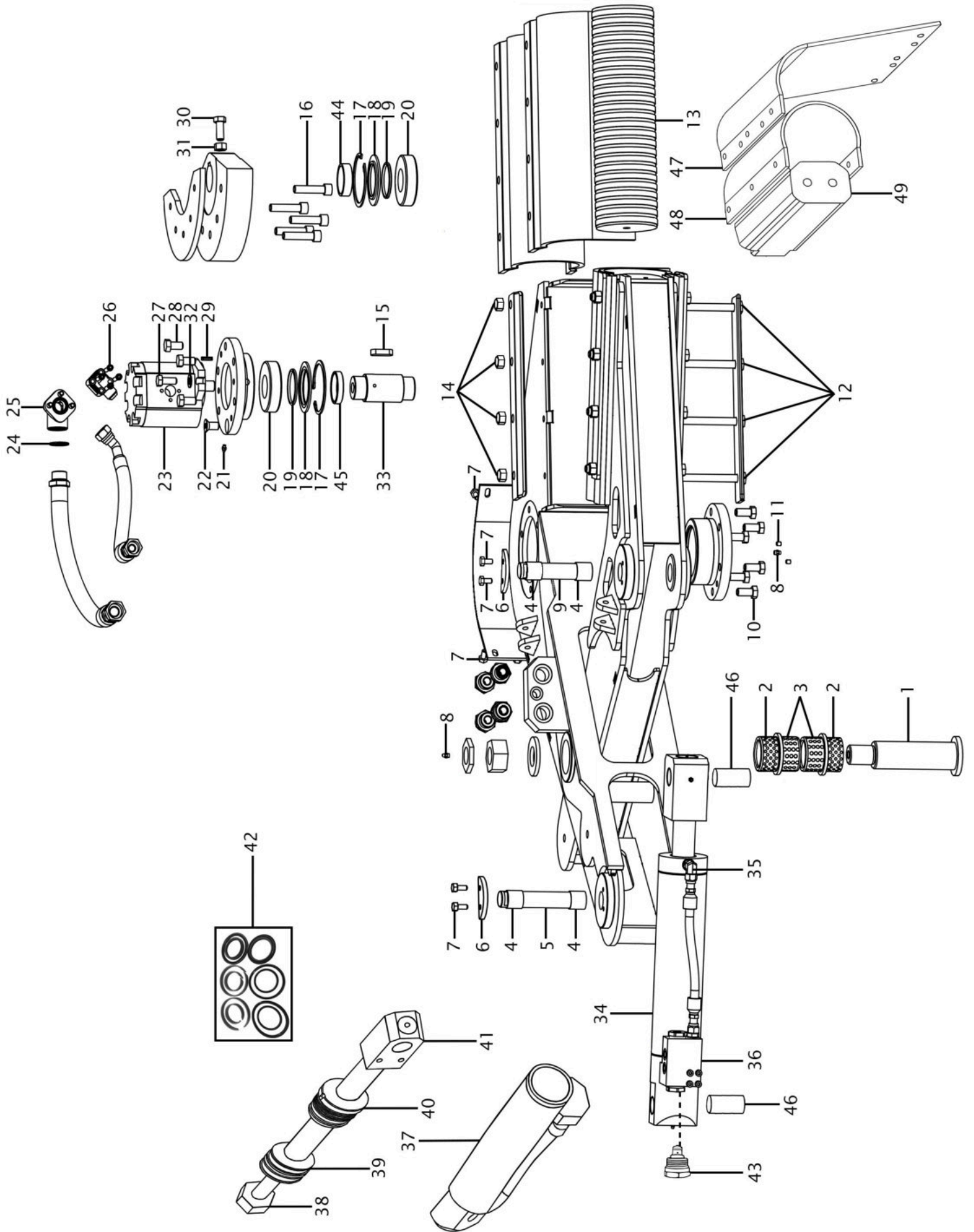

FIGURA	DESCRIPCIÓN	CÓDIGO
25	BRIDA 90° 1"	TP481
26	TORNILLO DE ALLEN 8x40-12.9	TP522
27	TORNILLO 14x35-12.9	TP479
28	TORNILLO 16x30-10.9	TP488
29	CHAVETA MOTOR	TP483
30	TORNILLO 16x40-10.9	TP477
31	TUERCA DE 16	TP519
32	ARANDELA PLANA 14	TP515
33	EJE EXCÉNTRICA	TP524
34	CILINDRO HIDRÁULICO PINZA	TP420
35	CODO MACHÓN BOTELLA	TP533
36	VÁLVULA RETENCIÓN	TP538
37	CAMISA CILINDRO HIDRÁULICO	TP539
38	CONTRATUERCA PISTÓN	TP540
39	PISTÓN CILINDRO HIDRÁULICO	TP541
40	CABEZA GUÍA CILINDRO HIDRÁULICO	TP542
41	VÁSTAGO CILINDRO HIDRÁULICO	TP543
42	JGO DE JUNTAS CILINDRO HIDRÁULICO	TP421
43	ANTIRETORNO FLUCOM CAE 25	TP553
44	CASQUILLO LARGO INFERIOR EJE PESA	TP552
45	CASQUILLO CORTO SUPERIOR EJE PESA	TP551
46	CASQUILLO BOTELLA	TP139
47	FALDILLA SUPERIOR MAZO CUADRADO	TP728
48	FALDILLA ABRAZA MAZO CUADRADO	TP727
49	MAZO VIBRADOR	TP720

PINZA CANGREJO

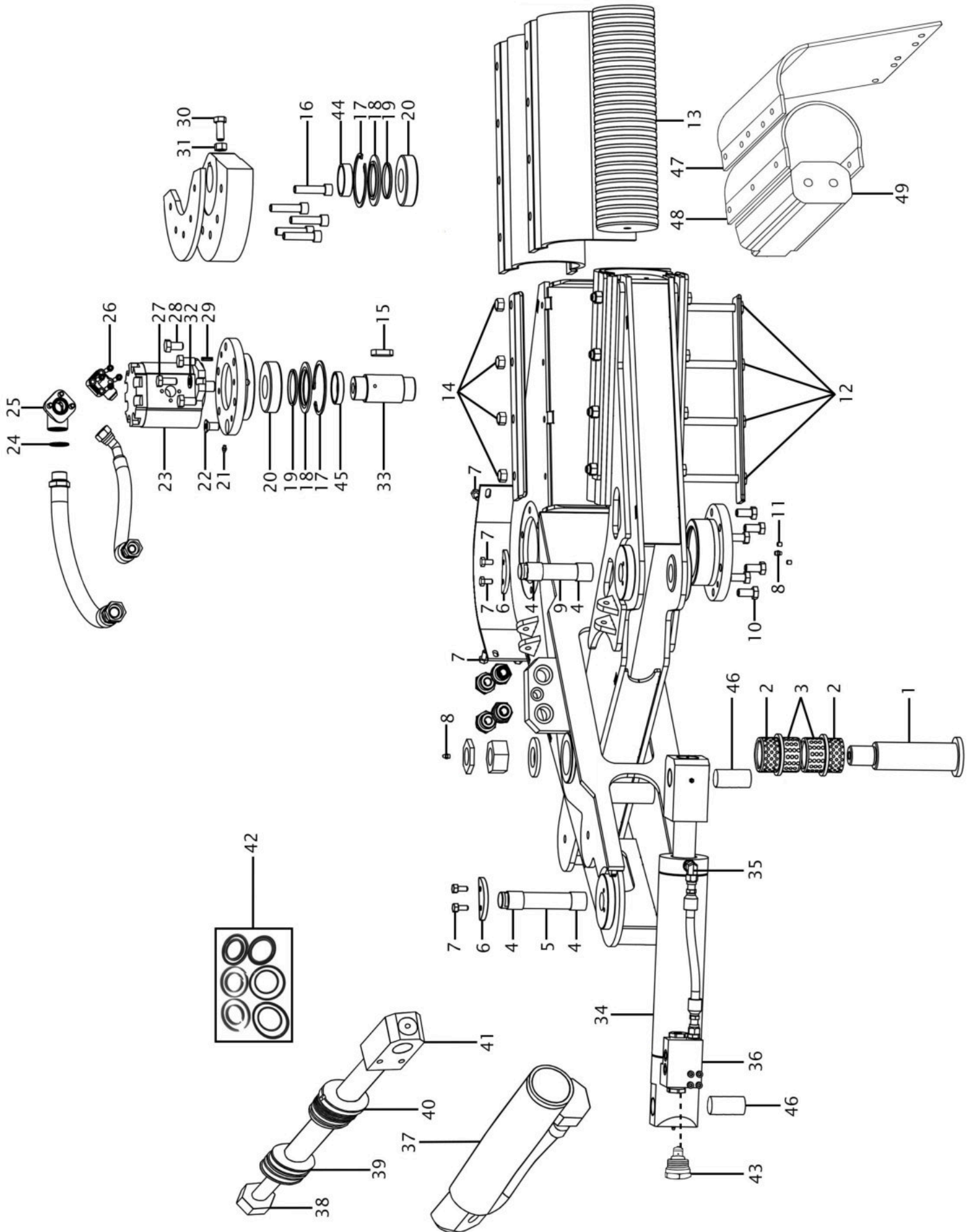

FIGURA	DESCRIPCIÓN	CÓDIGO
1	RODAMIENTO	TP467
2	RETÉN VIBRADOR	TP468
3	ARANDELA SUJECCIÓN RETÉN	TP469
4	ANILLO ELÁSTICO	TP470
5	CASQUILLO EJE EXCÉNTRICA	TP471
6	EJE EXCÉNTRICA	TP472
7	CHAVETA EJE EXCÉNTRICA	TP473
8	EXCÉNTRICA SUPERIOR VIBRADOR	TP474
9	EXCÉNTRICA CENTRAL VIBRADOR	TP475
10	EXCÉNTRICA INFERIOR VIBRADOR	TP476
11	TORNILLO 16x40-10.9	TP477
12	TORNILLO 16x100-12.9	TP478
13	TORNILLO 14x35-12.9	TP479
14	TORNILLO 10x30-12.9	TP480
15	BRIDA 90° 1"	TP481
16	MOTOR HIDRÁULICO	TP482
17	CHAVETA MOTOR	TP483
18	TORNILLO 8x25-8.8	TP484
19	BRIDA 90° 3/4	TP083
20	RACOR RECTO 3/4 GAS A 1.1/16 JIC	TP485
21	RACOR RECTO 1" GAS A 1.5/16 JIC	TP486
22	TORNILLO ALLEN CÓNICO 16x30-10.9	TP487
23	TORNILLO 16x30-10.9	TP488
24	PLATO SUPERIOR VIBRADOR	TP489
25	CASQUILLO CON VALONA	TP490

# PINZA CANGREJO

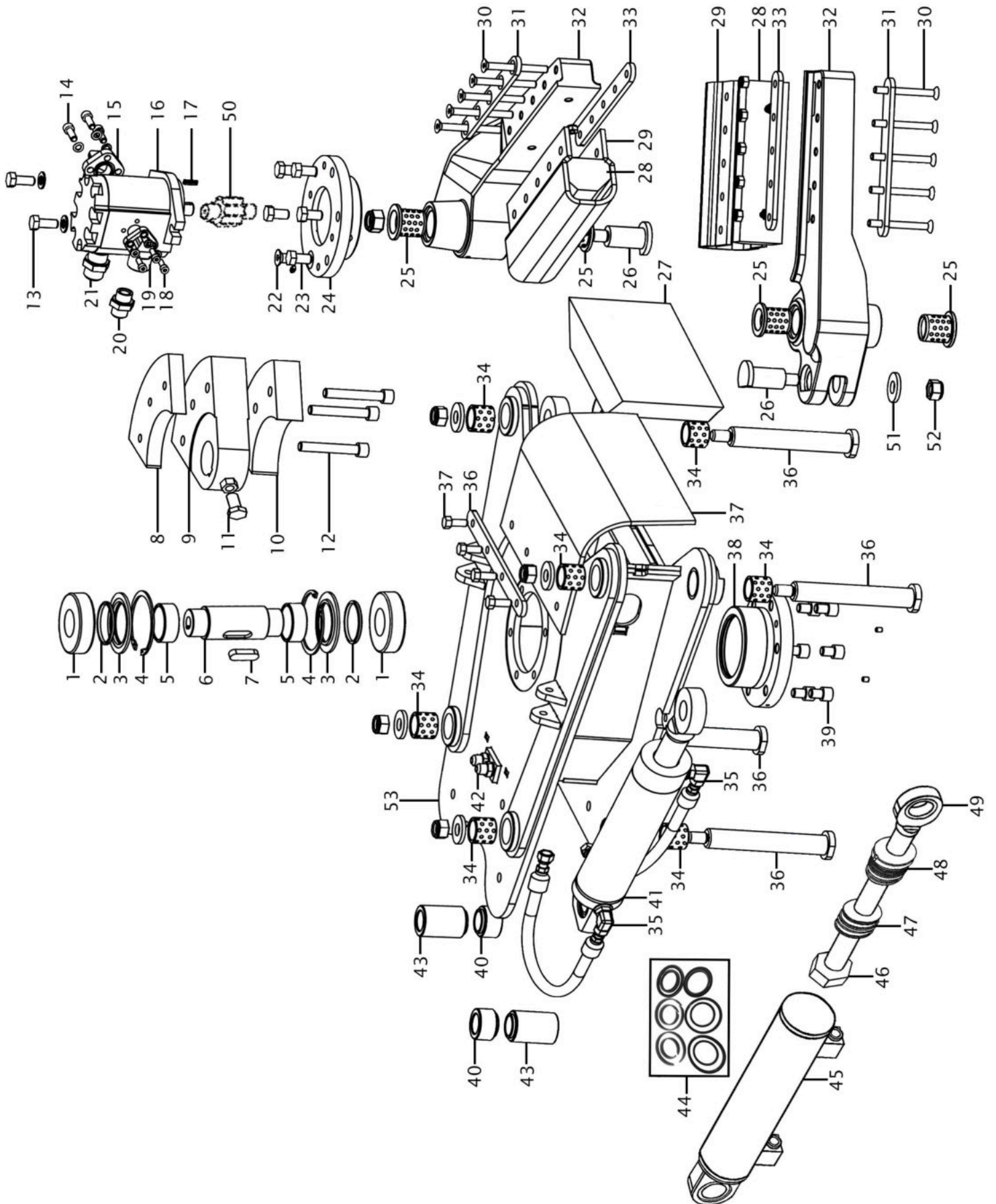

FIGURA	DESCRIPCIÓN	CÓDIGO
26	EJE PINZA	TP491
27	SILENTBLOCK PINZA CANGREJO 295x180x60	TP254
27	SILENTBLOCK PINZA CANGREJO 355x180x60	TP167
28	SILENTBLOCK TACO LATERAL	TP278
28	SILENTBLOCK TACO LATERAL BLANDO	TP060
29	FALDILLA TACO LATERAL	TP210
29	FALDILLA CAMELO TACO LATERAL	TP250
30	TORNILLO ALLEN CÓNICO 12x110-10.9	TP492
31	CHAPA SUJECCIÓN FALDILLA	TP493
32	BRAZO VIBRADOR TENAZA	TP494
33	CHAPA SUJECCIÓN FALDILLA	TP495
34	CASQUILLO AUTOLUBRICADO	TP496
35	RACOR CODO 90° 3/8-11/16 ORFS	TP497
36	EJE SEPARADOR	TP498
37	FALDILLA TACO FRONTAL	TP291
37	FALDILLA CAMELO TACO LATERAL	TP401
38	PLATO INFERIOR	TP499
39	TORNILLO ALLEN 16x20-10.9	TP500
40	CASQUILLO CORTO TRASERO VIBRADOR	TP501
41	CILINDRO PINZA VIBRADOR	TP368
42	RACOR RECTO 3/8 GAS A 3/4 JIC	TP454
43	CASQUILLO LARGO TRASERO VIBRADOR	TP502
44	JGO DE JUNTAS CILINDRO HIDRÁULICO PINZA CANGREJO	TP293
45	CAMISA CILINDRO HIDRÁULICO PINZA CANGREJO	TP503
46	CONTRATUERCA PISTÓN	TP134

PINZA CANGREJO



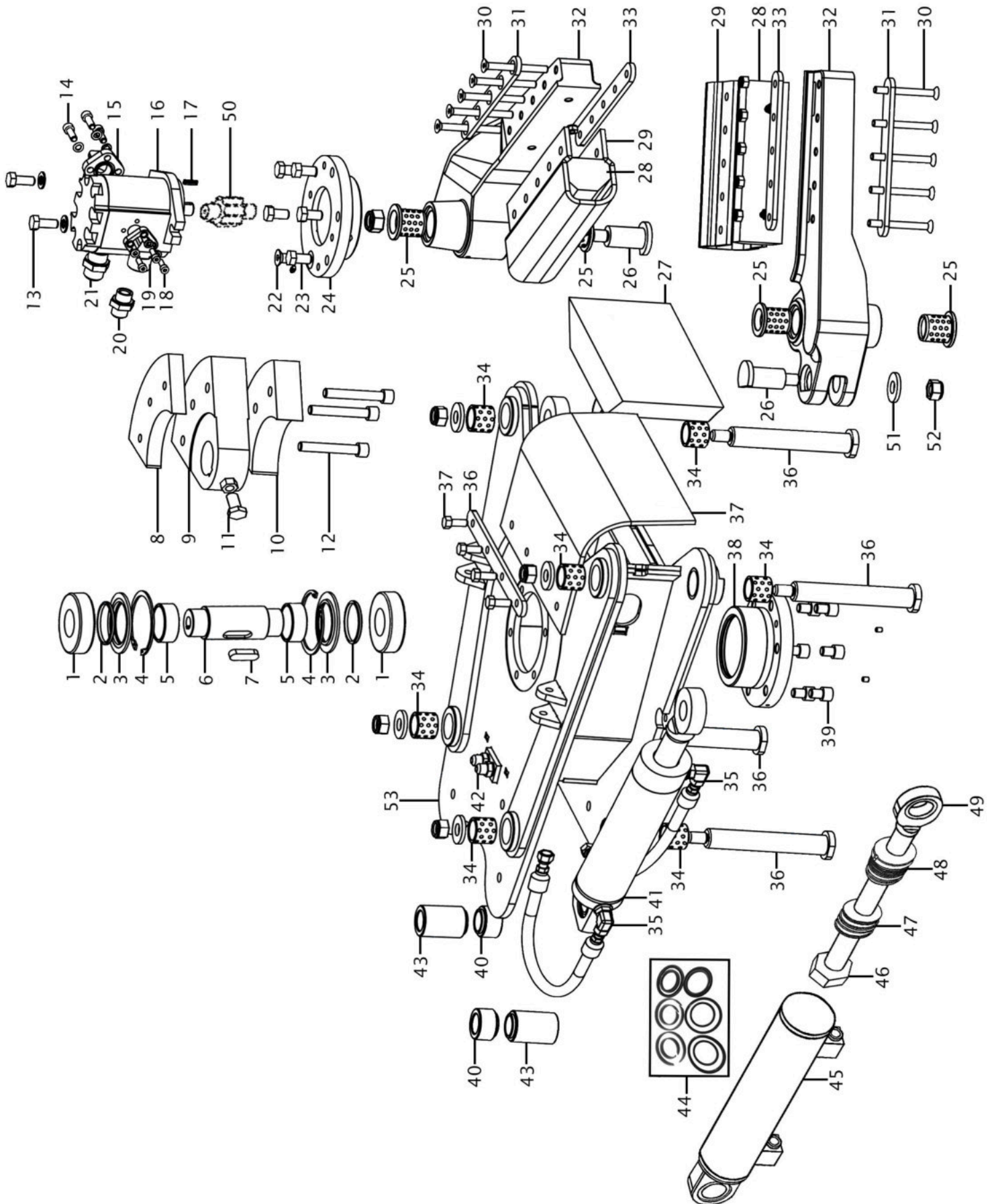
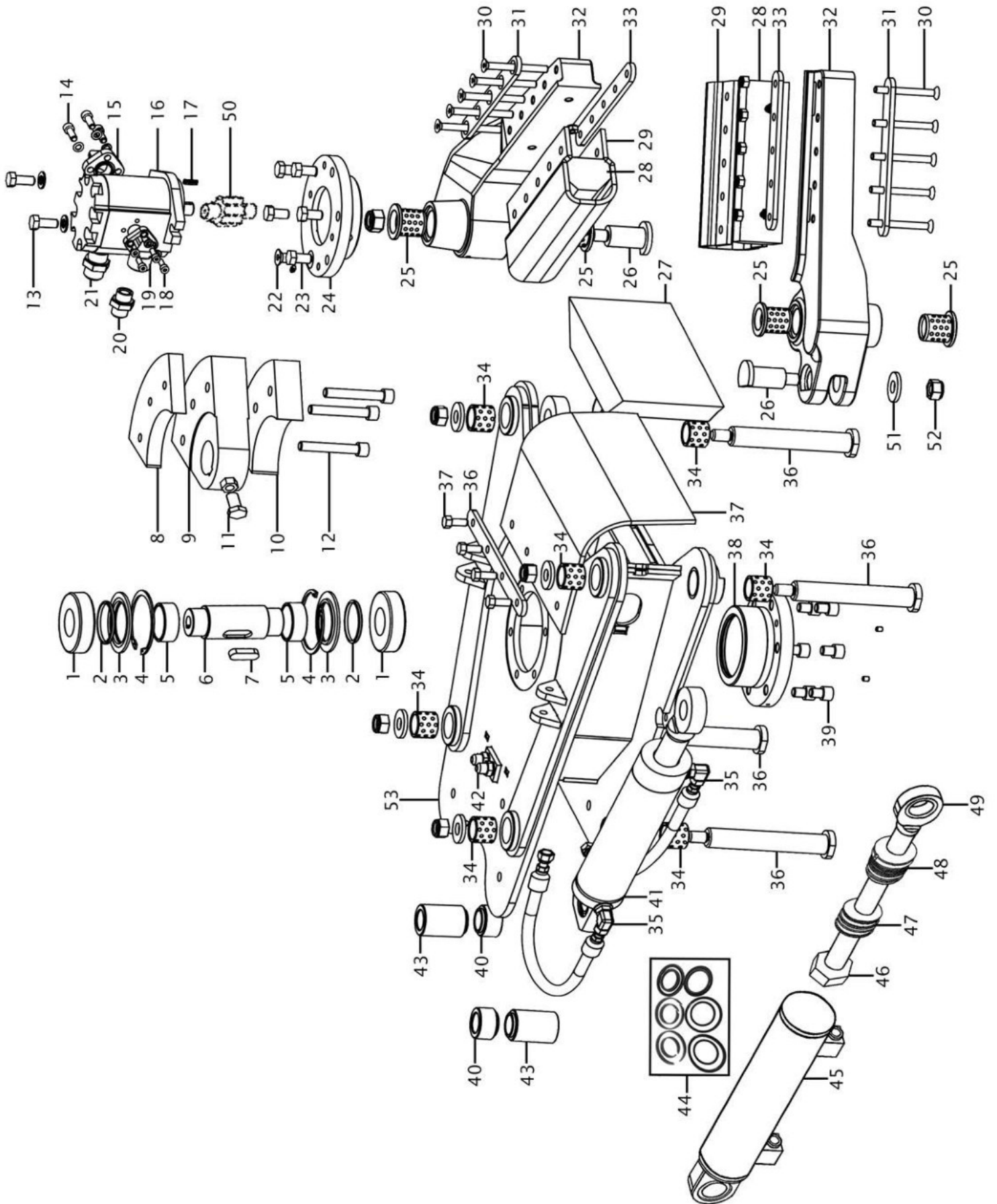

PINZA TENAZA (CANGREJO)

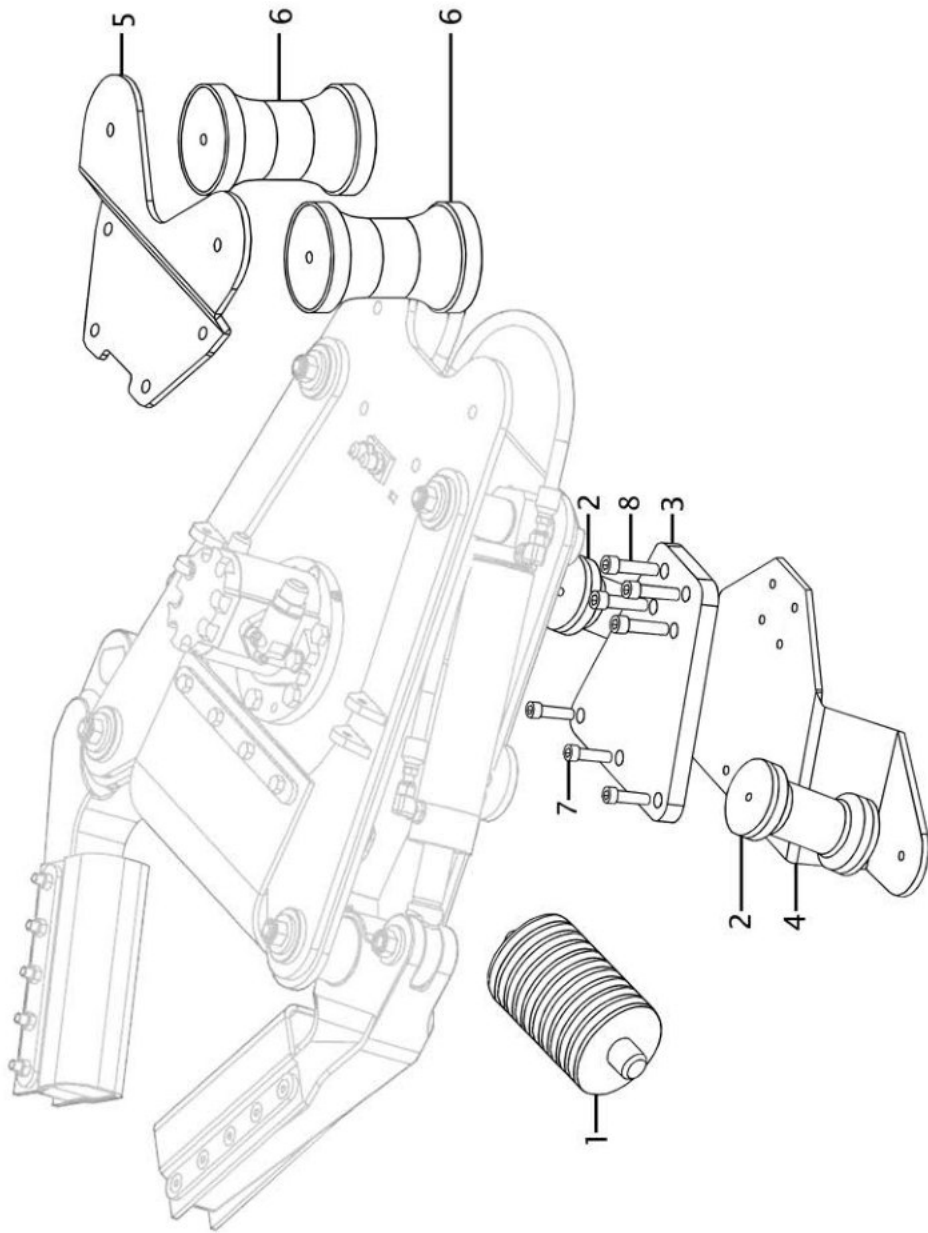



PINZA PROFESIONAL 2006



FIGURA	DESCRIPCIÓN	CÓDIGO
1	TACO VIBRADOR	TP367
2	FALDILLA TACO VIBRADOR	TP560
3	FALDILLA TACO VIBRADOR	TP561
4	TORNILLO 10x16-8.8	TP562
5	TAPA EXCÉNTRICA	TP563
6	TORNILLO ALLEN 24x130-12.9	TP564
7	EXCÉNTRICA INFERIOR	TP565
8	EXCÉNTRICA CENTRAL	TP566
9	EXCÉNTRICA SUPERIOR	TP567
10	RODAMIENTO EXCÉNTRICA	TP568
11	RETÉN EXCÉNTRICA	TP569
12	ARANDELA SUJECCIÓN	TP570
13	CLIP	TP571
14	CASQUILLO EJE EXCÉNTRICA	TP572
15	EJE EXCÉNTRICA	TP573
16	CHAVETA EJE EXCÉNTRICA	TP574
17	TORNILLO ALLEN 7/16x70-12.9	TP575
18	RACOR	TP576
19	TORNILLO 16x235-10.9	TP577
20	MOTOR DENISON	TP578
21	TORNILLO 16x35-10.9	TP579
22	TORNILLO 14x35-12.9	TP580
23	PLATO EXCÉNTRICA SUPERIOR	TP581
24	PLATO EXCÉNTRICA INFERIOR	TP582
25	TORNILLO 16x25-10.9	TP583

PINZA PROFESIONAL 2006

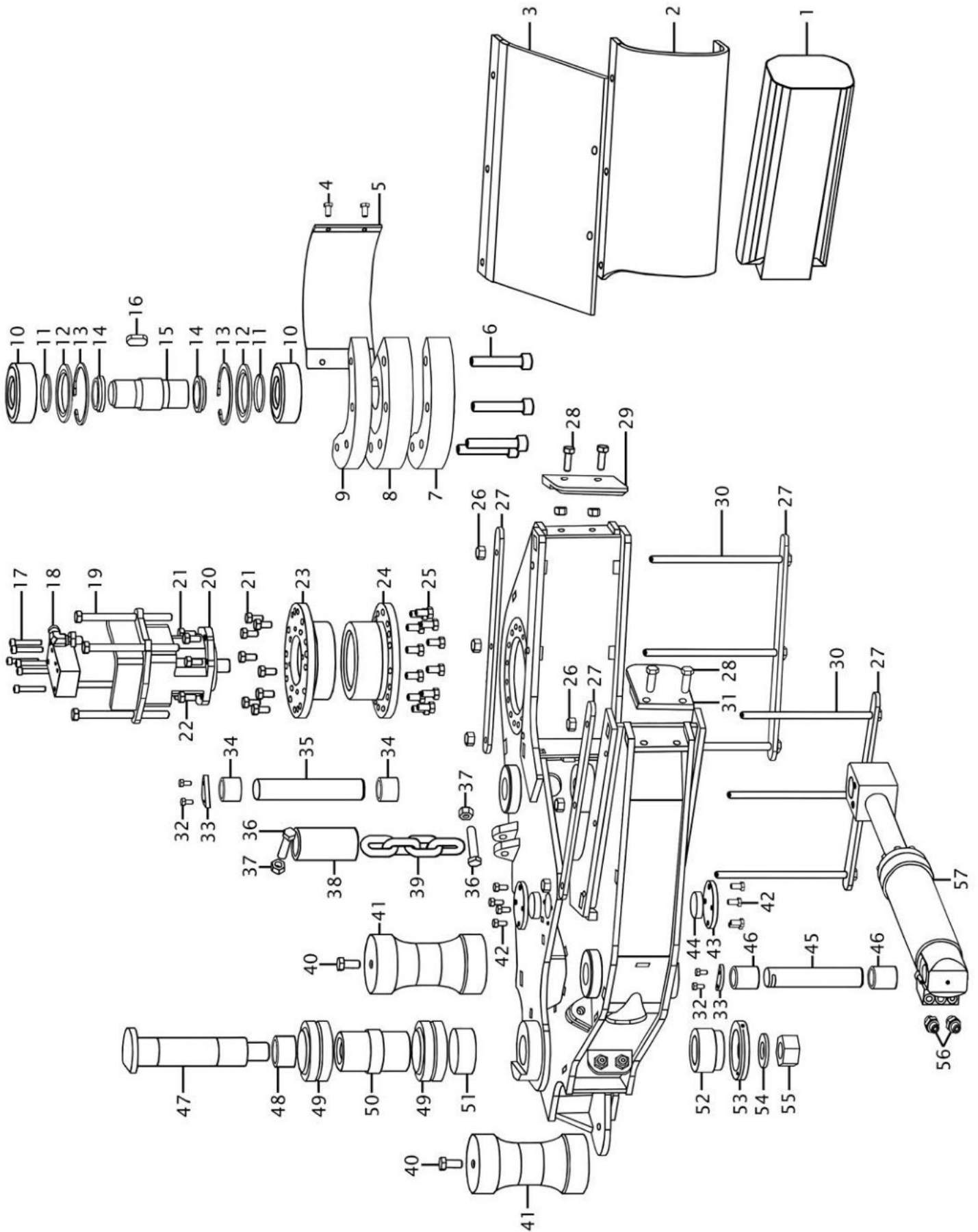

FIGURA	DESCRIPCIÓN	CÓDIGO
26	TUERCA DE FRENO 16x200	TP584
27	PLETINA SUJECCIÓN FALDILLA	TP585
28	TORNILLO 16x50-12.9	TP586
29	TOPE GOMA PINZA	TP587
30	TORNILLO 16x320-8.8	TP588
31	TOPE GOMA PINZA	TP589
32	TORNILLO 10x20-12.9	TP590
33	CHAPA PASADOR BULÓN	TP591
34	CASQUILLO	TP592
35	BULÓN LARGO	TP593
36	TORNILLO 18x90-150 12.9	TP594
37	TUERCA DE FRENO 18x150	TP595
38	GOMA PROTECCIÓN CADENA	TP596
39	CADENA ANTIDESGASTE	TP597
40	TORNILLO 16x40-10.9	TP598
41	SILENTBLOCK	TP599
42	TORNILLO 16x40-10.9	TP600
43	BRIDA DE APRIETE	TP601
44	CASQUILLO	TP602
45	BULÓN PEQUEÑO	TP603
46	CASQUILLO	TP604
47	BULÓN BISAGRA	TP605
48	CASQUILLO	TP606
49	RÓTULA	TP607
50	CASQUILLO	TP608

PINZA PROFESIONAL 2006



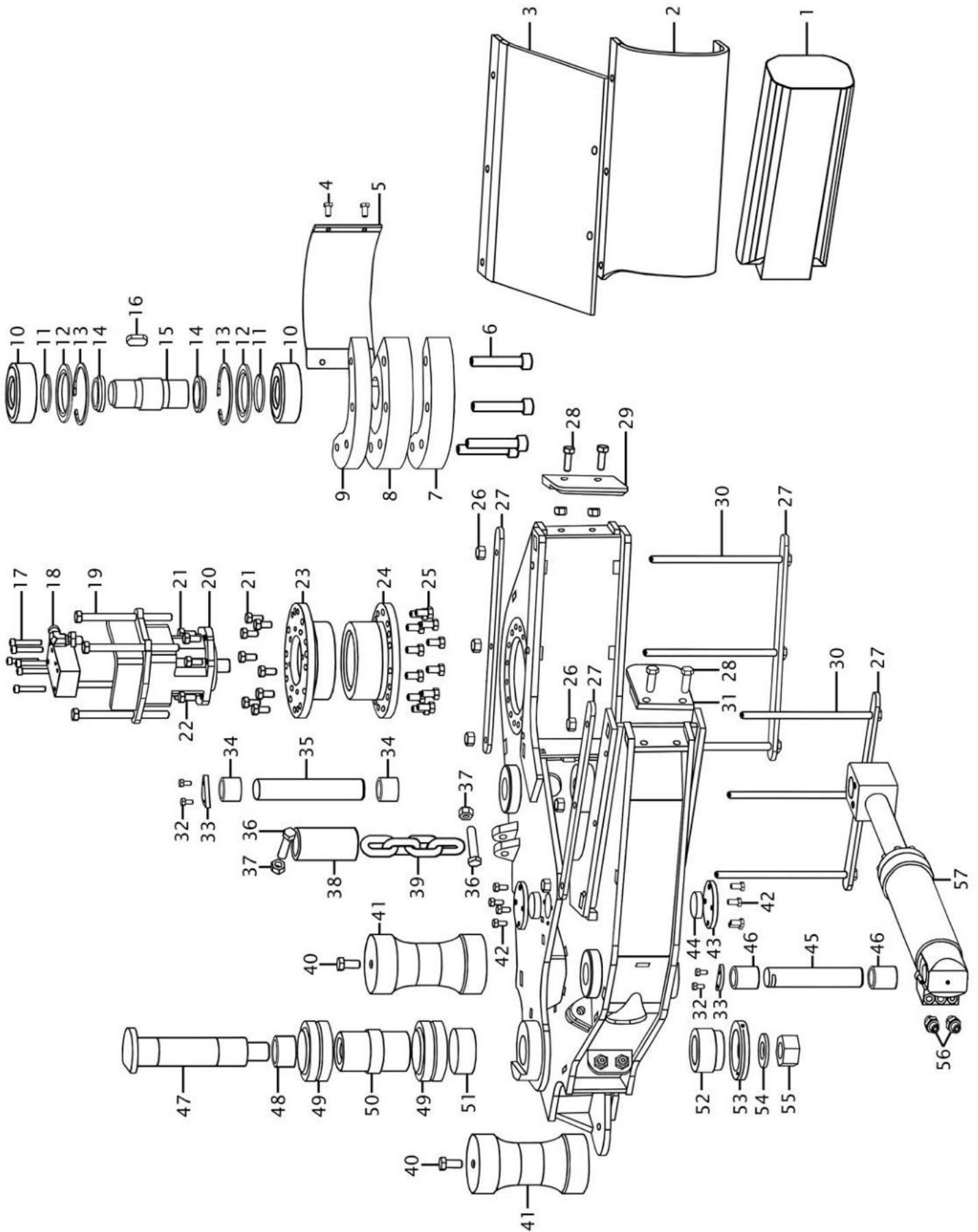
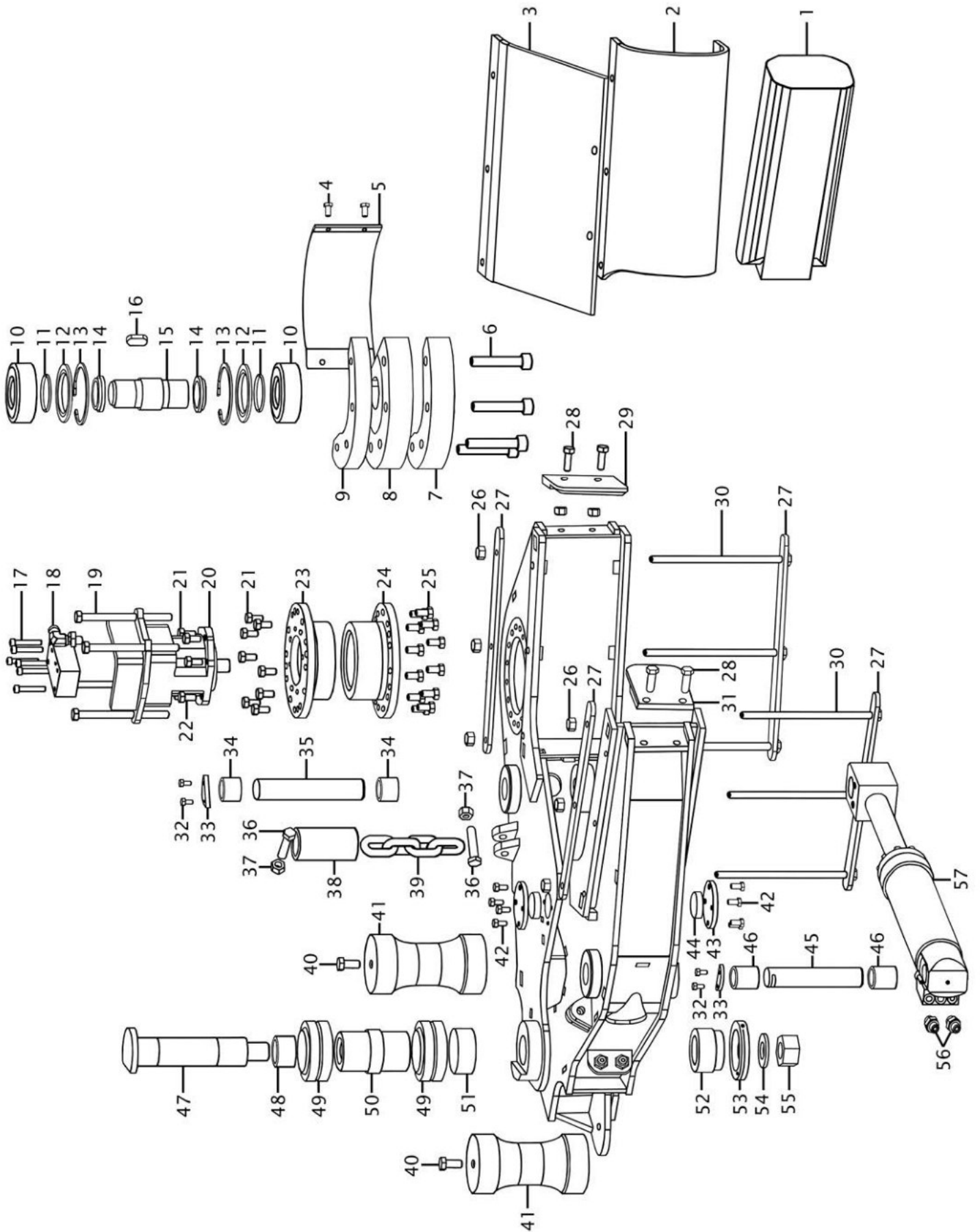

PINZA PROFESIONAL 2017



FIGURA	DESCRIPCIÓN	CÓDIGO
1	TORNILLO 16x330-8.8	TP617
2	PLETINA SUJECCIÓN FALDILLA	TP585
3	TACO VIBRADOR	TP367
4	TUERCA DE FRENO DE 16	TP521
5	FALDILLA TACO VIBRADOR	TP560
6	FALDILLA TACO VIBRADOR	TP618
7	MACHÓN 11/16 ORFS-3/8 GAS	TP095
8	CILINDRO HIDRÁULICO	TP619
9	TOPE GOMA PINZA	TP589
10	TORNILLO 16x50-12.9	TP586
11	TORNILLO 12x25-10.9	TP600
12	TORNILLO 16x50-8.8	TP620
13	BRIDA APRIETE	TP601
14	CASQUILLO	TP602
15	CASQUILLO	TP609
16	TUERCA 45x150	TP613
17	ARANDELA BULÓN BISAGRA	TP612
18	TUERCA DE APRIETE	TP611
19	CASQUILLO APRIETE RÓTULA	TP621
20	RÓTULA	TP607
21	CASQUILLO INTERIOR BISAGRA	TP608
22	BULÓN BISAGRA VIBRADOR	TP622
23	CASQUILLO	TP606
24	SILENTBLOCK VIBRADOR 140x270 M16	TP347
25	TUERCA DE FRENO 18-150	TP595

PINZA PROFESIONAL 2017





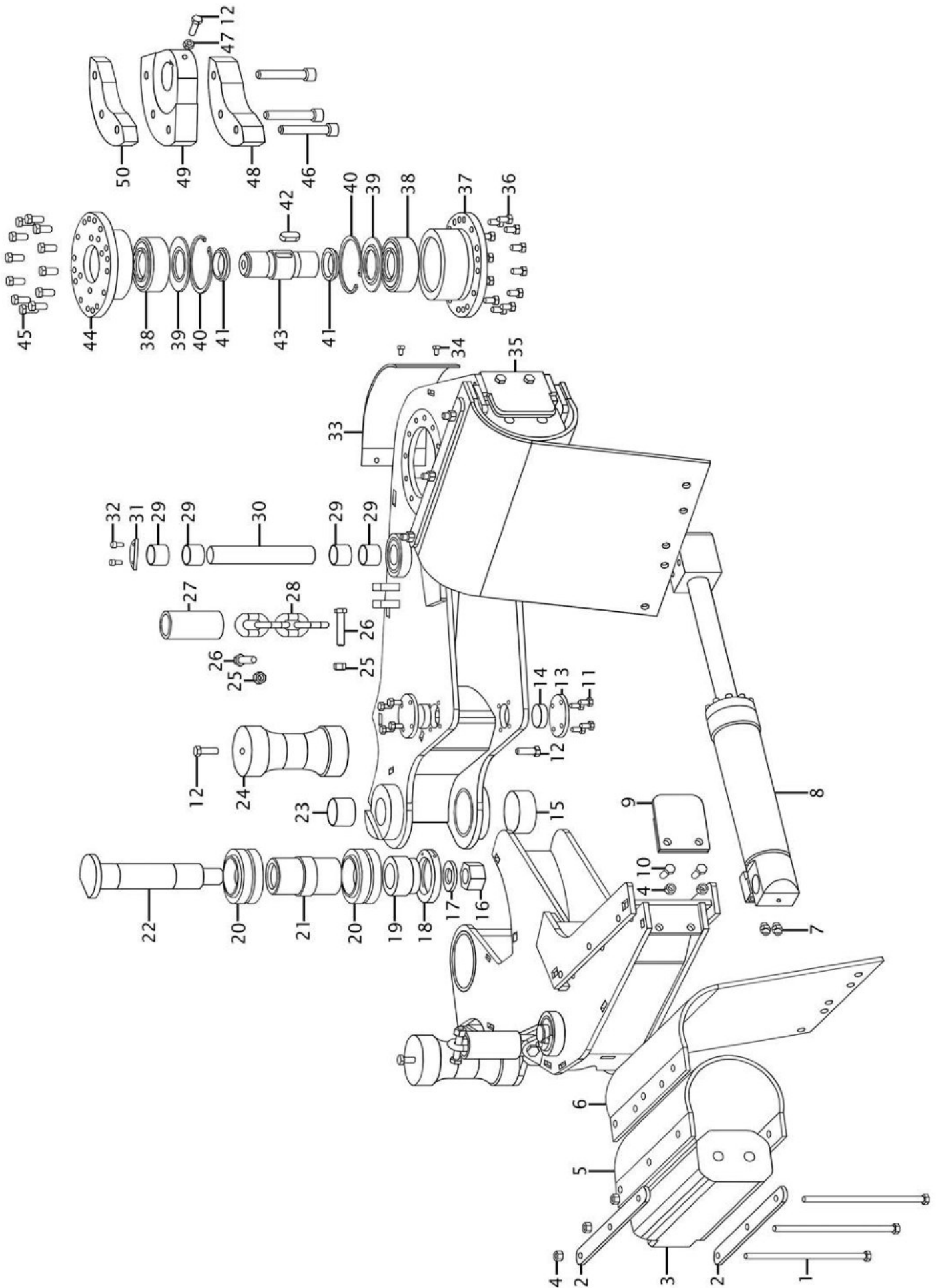





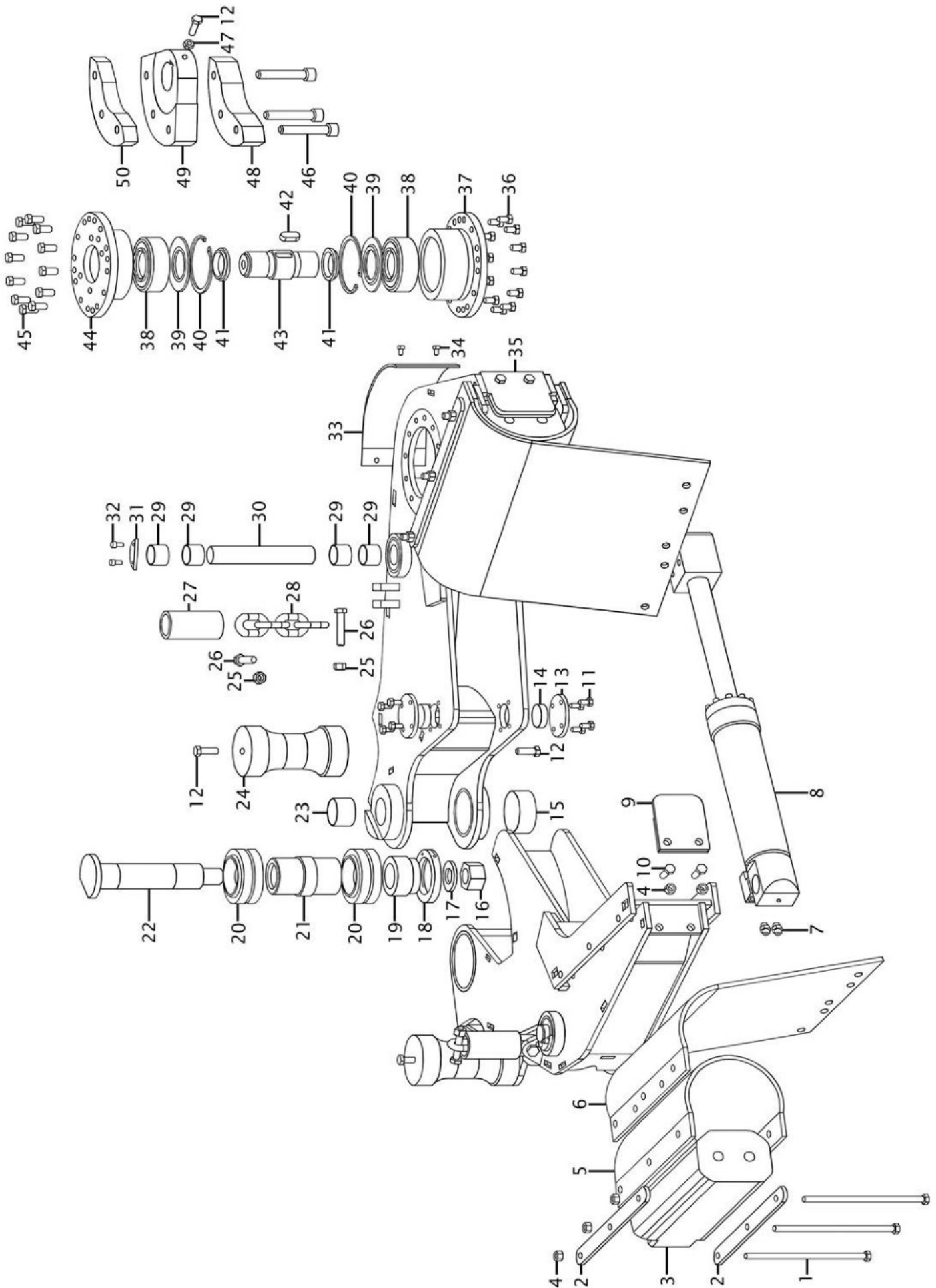
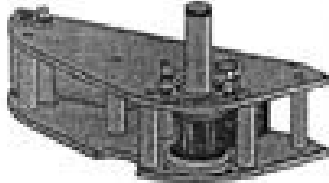





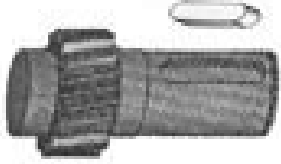

FIGURA	DESCRIPCIÓN	CÓDIGO
26	TORNILLO 18x90-150 12.9	TP624
27	GOMA PROTECCIÓN CADENA	TP596
28	CADENA ANTIDESGASTE	TP597
29	CASQUILLO	TP592
30	BULÓN LARGO	TP625
31	CHAPA PASADOR BULÓN	TP591
32	TORNILLO DE ALLEN 10x20-12.9	TP626
33	TAPA EXCÉNTRICA	TP563
34	TORNILLO 10x16-8.8	TP562
35	TOPE GOMA PINZA	TP587
36	TORNILLO 16x25-10.9	TP583
37	PLATO EXCÉNTRICA INFERIOR	TP582
38	RODAMIENTO EXCÉNTRICA	TP568
39	ARANDELA SUJECCIÓN	TP570
40	CLIP	TP571
41	CASQUILLO EJE EXCÉNTRICA	TP572
42	CHAVETA EJE EXCÉNTRICA	TP574
43	EJE ESTRIADO EXCÉNTRICA	TP627
44	PLATO EXCÉNTRICA SUPERIOR	TP628
45	TORNILLO 16x35-10.9	TP509
46	TORNILLO DE ALLEN 24x130-12.9	TP564
47	TUERCA DE 16	TP519
48	EXCÉNTRICA INFERIOR	TP565
49	EXCÉNTRICA CENTRAL	TP566
50	EXCÉNTRICA SUPERIOR	TP567

CAJA NEGRA PV

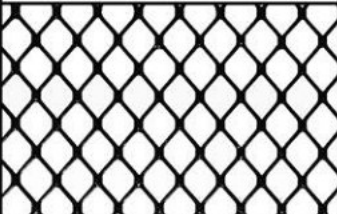
	CAJA NEGRA DERECHA PV	TP257
	CAJA NEGRA IZQUIERDA PV	TP256
	CAJA NEGRA DERECHA PV COMPLETA	TP279
	CAJA NEGRA IZQUIERDA PV COMPLETA	TP280
	ARANDELA CIERRE RODAMIENTOS CAJA NEGRA	TP281
	CILINDRO CON RÓTULA	TP010
	CILINDRO CAJA NEGRA ANTIGUO	TP042
	BULÓN TRASERO CILINDRO 18x70	TP043
	BULÓN RÓTULA 20x51	TP044
	BULÓN CILINDRO ANTIGUO 18x51	TP045
	BULÓN PIÑÓN EXCÉNTRICA 30x70	TP046
	PIÑÓN EXCÉNTRICA RECTO	TP047
	PIÑÓN EXCÉNTRICA HELICOIDAL	TP048
	EJE DE MANDO RECTO	TP049
	EJE DE MANDO HELICOIDAL	TP050
	CHAVETA PLANA (10x8x60)	TP159

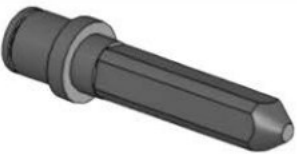
	CHAPA SUJECCIÓN FALDILLA PV	TP266
	CHAPA SUJECCIÓN FALDILLA PV CON TUERCA M-8	TP265
	CADENA DE ACERO PV	TP350
	KIT REPARACIÓN CILINDRO INCLINACIÓN PV	TP349
	MAZO PV 530x200x150	TP367
	MALLA PROTECCIÓN CABINA PV	TP391
	EJE MOTOR PELADORA PV ESTRIADO	TP244
	SILENTBLOCK DEPÓSITO DE ACEITE	TP460
	EJE MOTOR PELADORA PV 175mm CHAVETA 5mm	TP740
	EJE MOTOR PELADOR PV 175mm CHAVETA 6,3mm	TP650
	EJE MOTOR PELADORA PV 180mm CHAVETA 5mm	TP749
	EJE MOTOR PELADOR PV 180mm CHAVETA 6,3mm	TP658
	EJE ESTRIADO MOTOR PELADORA PV Z13 180mm	TP659
	CADENA TIJERA 10x35 6 ESLABONES	TP725
	JGO REPARACIÓN VIBRADOR LIGERO 2004-2005	TP691
	JGO REPARACIÓN VIB.REFORZADO/PROFESIONAL 2004	TP692
	JGO REPARACIÓN VIBRADOR LIGERO 2001-2003	TP693
	CILINDRO TRAMPILLA PV HASTA 2003	TP756
	EJE SUJECCIÓN CABEZAL A CHASIS PV	TP723